



Valves, Fittings and Tubing

Medium and High Pressure

aerospace
climate control
electromechanical
filtration
fluid & gas handling
hydraulics
pneumatics
process control
sealing & shielding



ENGINEERING YOUR SUCCESS.

Section	Page
Introduction	2
Manual Needle Valves	3
Air Actuators (for P-AE Needle Valves)	4
Fittings, Components & Accessories	7
Tubing.	8
Coned and Threaded Nipples	9
Anti-Vibration Collet Gland Assemblies	10
Male/Female Adapters.	11
Adapter Couplings.	12
Ball Valves.	13
Instrument Quality Gauges	14
Manifolds and Relief Valves	15
Tools	16
Connections.	18
Flow Calculations	19
Sour Service Products.	20

The world leader in high pressure valves, fittings and tubing

Since its inception in 1945, Parker Autoclave Engineers (P-AE) has been dedicated to manufacturing high pressure and extreme temperature valve, fitting, and instrument tubing systems which are coordinated together to operate safely and reliably. Today, Parker Autoclave Engineers is a world leader combining our high pressure knowledge, manufacturing expertise, and technological innovation to offer a broad range of products and services to our customers, across a wide range of industries.

Low Pressure (0-15,000 psi) Valves, Fittings and Tubing

While Parker Autoclave Engineers products are known industry wide for their ability to operate at pressures in excess of 150,000 psi (10,340 bar), a Low Pressure line nicknamed “Speedbite”, rated for applications to 15,000 psi (1034 bar) is available, but not discussed in this brochure. Speedbite valves and fittings utilize a single ferrule compression sleeve connection which provides easy, leak free performance, matched to P-AE specified instrument tubing sizes from 1/16” to 1/2”.

QSS - Quick Set System (0-15,000 psi)

Recently, to enhance the Speedbite product line, Parker Autoclave Engineers engineered (not shown in this catalog) an advanced single ferrule fitting system called the QSS-Quick Set System. Designed to work with our Medium Pressure 316 cold worked S.S. and 2507 Super Duplex™ instrument tubing, this 1/4” through 1” O.D. connection is utilized in our valves and fittings to provide a simple to install connection in all sizes up to 15,000 psi (1034 bar). For more information, or to order a complete catalog, contact your nearest Parker Autoclave Engineers representative.

Needle Valves

All Parker Autoclave Engineers Needle Valves incorporate a rising stem/block design while the non-rotating feature of the stem prevents galling. In addition, the valves are designed with metal to metal seating for bubble tight shut-off, long stem/seat life even in abrasive flow conditions, and excellent overall corrosion resistance.

Valve Pattern options are shown in the next section. Three different stem types are available. A Vee stem is chosen when the application calls for direct on-off, metal to metal shut-off with fast opening capabilities. If an application calls for tighter flow control, Parker Autoclave Engineers offers a non-rotating regulating stem, and for the most precise flow control, Parker Autoclave Engineers recommends a MicroMetering™ stem design.

Each pressure group has a complete line of valves, tubing and fittings as well as specialty items, providing all the components required to complete any HP/HT project. Parker Autoclave Engineers components are offered in 316SS as standard, but can be ordered in a variety of optional materials such as: Super Duplex, 6Mo, Hastelloy* B & C, Inconel, Monel, Nickel, Titanium or any one of our 40 other supported materials.

For more information see our website at www.Autoclave.com. To order a complete VFT Catalog, contact your nearest Parker Autoclave Engineers representative or the company direct at 814-860-5700.

* Hastelloy is a trademark of Haynes International Inc.

Manual Needle Valves

Parker Autoclave Engineers valves are designed to operate safely and reliably at pressures to 150,000 psi (10342 bar). Several important features make this dependable service possible under widely varying conditions.

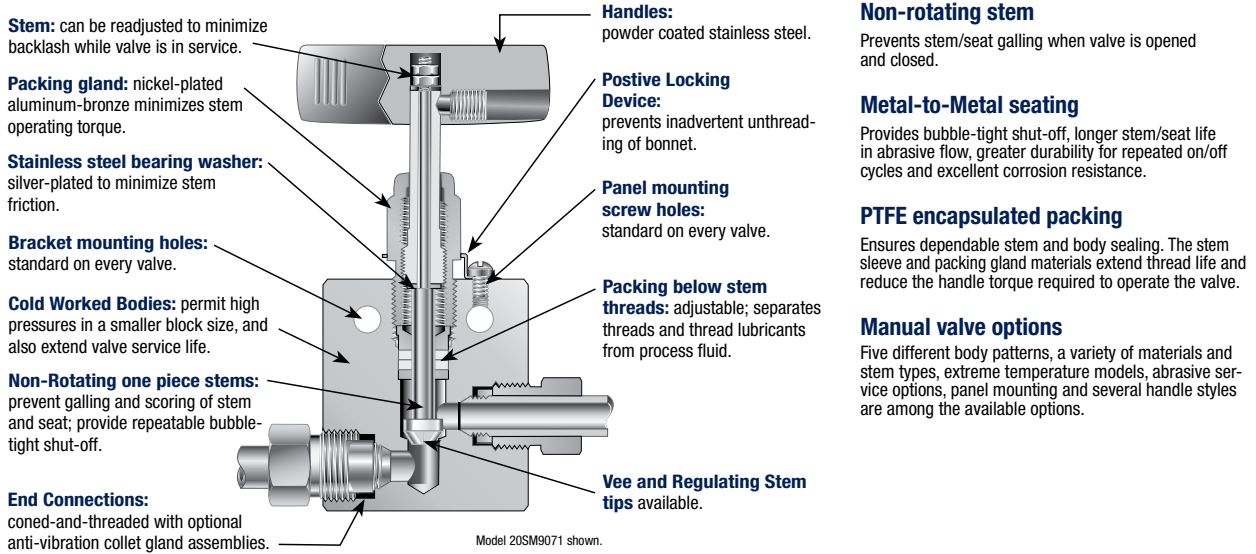

	O.D. Tube Size In (mm)	Pressure Rating psi (bar)	*Rated C _v (full open)	Valve Stem Type	Valve Stem Type					
					2 Way Straight	2 Way Angle	3 Way 2 on Pressure	3 Way 1 on Pressure	2 Way Angle Replaceable Seat	3 Way 2 Stem Manifold
Medium Pressure	1/4 (6.35)	20,000 (1380)	.31	Vee Reg	20SM4071 20SM4081	20SM4072 20SM4082	20SM4073 20SM4083	20SM4074 20SM4084	20SM4872 20SM4882	20SM4075 20SM4085
	3/8 (9.53)	20,000 (1380)	.75	Vee Reg	20SM6071 20SM6081	20SM6072 20SM6082	20SM6073 20SM6083	20SM6074 20SM6084	20SM6872 20SM6882	20SM6075 20SM6085
	9/16 (14.30)	20,000 (1380)	1.30	Vee Reg	20SM9071 20SM9081	20SM9072 20SM9082	20SM9073 20SM9083	20SM9074 20SM9084	20SM9872 20SM9882	20SM9075 20SM9085
	3/4 (19.10)	20,000 (1380)	2.50	Vee Reg	20SM12071 20SM12081	20SM12072 20SM12082	20SM12073 20SM12083	20SM12074 20SM12084	20SM12872 20SM12882	20SM12075 20SM12085
	1 (25.40)	20,000 (1380)	4.40	Vee Reg	20SM16071 20SM16081	20SM16072 20SM16082	20SM16073 20SM16083	20SM16074 20SM16084	20SM16872 20SM16882	20SM16075 20SM16085
	9/16 (14.30)	10,000 (690)	1.75	Vee Reg	10SM9071 10SM9081	10SM9072 10SM9082	10SM9073 10SM9083	10SM9074 10SM9084	10SM9872 10SM9882	10SM9075 10SM9085
	3/4 (19.10)	10,000 (690)	2.80	Vee Reg	10SM12071 10SM12081	10SM12072 10SM12082	10SM12073 10SM12083	10SM12074 10SM12084	10SM12872 10SM12882	10SM12075 10SM12085
1 (25.40)	10,000 (690)	5.20	Vee Reg	10SM16071 10SM16081	10SM16072 10SM16082	10SM16073 10SM16083	10SM16074 10SM16084	10SM16872 10SM16882	10SM16075 10SM16085	
High Pressure	1 (25.40)	30,000 (2070)	2.60	Vee Reg	30SC16071 30SC16081	30SC16072 30SC16082	30SC16073 30SC16083	30SC16074 30SC16084	30SC16872 30SC16882	30SC16075 30SC16085
	1/4 (6.35)	30,000 (2070)	.12	Vee Reg	30VM4071 30VM4081	30VM4072 30VM4082	30VM4073 30VM4083	30VM4074 30VM4084	30VM4872 30VM4882	30VM4075 30VM4085
	3/8 (9.53)	30,000 (2070)	.23	Vee Reg	30VM6071 30VM6081	30VM6072 30VM6082	30VM6073 30VM6083	30VM6074 30VM6084	30VM6872 30VM6882	30VM6075 30VM6085
	9/16 (14.30)	30,000 (2070)	.33	Vee Reg	30VM9071 30VM9081	30VM9072 30VM9082	30VM9073 30VM9083	30VM9074 30VM9084	30VM9872 30VM9882	30VM9075 30VM9085
	9/16 (14.30)	40,000 (2760)	.28	Vee Reg	40VM9071 40VM9081	40VM9072 40VM9082	40VM9073 40VM9083	40VM9074 40VM9084	40VM9872 40VM9882	40VM9075 40VM9085
	1/4 (6.35)	60,000 (4140)	.08	Vee Reg	60VM4071 60VM4081	60VM4072 60VM4082	60VM4073 60VM4083	60VM4074 60VM4084	60VM4872 60VM4882	60VM4075 60VM4085
	3/8 (9.53)	60,000 (4140)	.09	Vee Reg	60VM6071 60VM6081	60VM6072 60VM6082	60VM6073 60VM6083	60VM6074 60VM6084	60VM6872 60VM6882	60VM6075 60VM6085
	9/16 (14.30)	60,000 (4140)	.14	Vee Reg	60VM9071 60VM9081	60VM9072 60VM9082	60VM9073 60VM9083	60VM9074 60VM9084	60VM9872 60VM9882	60VM9075 60VM9085

* C_v Values shown are for 2-way straight pattern. For 2-way angle, increase C_v Valve 30%. Note: SM Series replaces 20SC Series

Air Actuators (for P-AE Needle Valves)

Three sizes of air operators (medium, heavy duty or extra heavy) are offered for remote on-off operation or automatic operation of Parker Autoclave Engineers medium or high pressure valves. The actuators are available in air-to-open (normally closed) and air-to-close (normally open) designs.

Ordering Procedure (Consult factory to insure proper selection)

To order a valve with an air operator, select the duty rating and type of the air operator from the chart on page 5 & 6. Add the air operator identifying suffix to the catalog number of the Parker Autoclave Engineers valve. To order a 2-way straight, 30VM vee stem, 9/16" (14.3 mm) valve with a medium duty air-to-close piston air operator, specify: ex: 30VM9071-C1S. For a high pressure diaphragm operated air actuated valve, an example would be: 30VM9071-CM.

Duty Rating	Operator	Type	Order Suffix
Medium	Diaphragm	Air to Open	OM
		Air to Close	CM
	Piston	Air to Open	O1S
		Air to Close	C1S
Heavy	Diaphragm	Air to Open	OH
		Air to Close	CH
	Piston	Air to Open	O2S
		Air to Close	C2S
Extra Heavy Single Stage	Piston	Air to Open	HO1S
		Air to Close	HC1S
Extra Heavy Two Stage	Piston	Air to Open	HO2S
		Air to Close	HC2S



60VM9071-OM
Air To Open
Piston Activated

Note: For outdoor service actuators, please see main catalog.



Air Actuators (for P-AE Needle Valves)



10V6071-C1S
Air To Close
Piston Activated

This table is designed to allow quick selection of an appropriate piston or diaphragm air actuator based on valve style and size, maximum system operating pressure and maximum available air pressure.

For example, if the system operating pressure is 25,000 psi (1723 bar) and the available air pressure is 60 psi (4.1 bar) and an air-to-open (spring fail closed) valve is required, a 30VM or 60VM valve with a heavy duty air operator can be used.

Note: See main catalog for complete sizing information.

Air to Close: Actuator Selection Guide

Valve Series	O.D. Tube in. (mm)	Medium		Heavy		Extra Heavy Single Stage		Extra Heavy Two Stage	
		System Pressure psi (bar)	Air Pressure psi (bar)	System Pressure psi (bar)	Air Pressure psi (bar)	System Pressure psi (bar)	Air Pressure psi (bar)	System Pressure psi (bar)	Air Pressure psi (bar)
10SM	9/16 (14.30)	8,600 (593)	100 (6.9)	10,000 (690)	55 (3.8)	10,000 (690)	45 (3.10)	10,000 (690)	20 (1.4)
	3/4 (19.10)	4,800 (331)	100 (6.9)	10,000 (690)	100 (6.9)	10,000 (690)	70 (4.83)	10,000 (690)	35 (2.4)
	1 (25.40)	2,800 (193)	100 (6.9)	6,300 (434)	100 (6.9)	8,500 (586)	95 (6.55)	10,000 (690)	55 (3.79)
20SM	1/4 (6.35)	20,000 (1380)	95 (6.5)	20,000 (1380)	50 (3.5)	-	-	-	-
	3/8 (9.53)	19,000 (1310)	100 (6.9)	20,000 (1380)	55 (3.8)	-	-	-	-
	9/16 (14.30)	10,700 (734)	100 (6.9)	20,000 (1380)	85 (5.9)	20,000 (1380)	65 (4.48)	20,000 (1380)	30 (2.1)
	3/4 (19.10)	6,100 (421)	100 (6.9)	13,600 (938)	100 (6.9)	19,000 (1310)	100 (6.90)	20,000 (1380)	50 (3.4)
	1 (25.40)	3,900 (269)	100 (6.9)	8,800 (607)	100 (6.9)	12,500 (862)	100 (6.90)	20,000 (1380)	75 (5.1)
30SC	1 (25.40)	-	-	-	-	-	-	30,000 (2068)	80 (5.5)
30VM	1/4 (6.35)	30,000 (2068)	55 (3.8)	30,000 (2068)	30 (2.0)	-	-	-	-
	3/8 (9.53)	30,000 (2068)	75 (5.2)	30,000 (2068)	40 (2.8)	-	-	-	-
	9/16 (14.30)	30,000 (2068)	75 (5.2)	30,000 (2068)	40 (2.8)	-	-	-	-
40VM	9/16 (14.30)	40,000 (2758)	90 (6.2)	40,000 (2758)	45 (3.1)	-	-	-	-
60VM	1/4 (6.35)	60,000 (4137)	75 (5.2)	60,000 (4137)	40 (2.8)	-	-	-	-
	3/8 (9.53)	60,000 (4137)	75 (5.2)	60,000 (4137)	40 (2.8)	-	-	-	-
	9/16 (14.30)	60,000 (4137)	90 (6.2)	60,000 (4137)	45 (3.1)	-	-	-	-

Note: Actuator Selection Guide (choose actuator based on available air pressure)

Air Actuators (for P-AE Needle Valves)

This table is designed to allow quick selection of an appropriate piston and diaphragm air actuator based on valve style and size, maximum system operating pressure and maximum available air pressure.

For example, if the system operating pressure is 25,000 psi (1723 bar) and the available air pressure is 60 psi (4.1 bar) and an air-to-open (spring fail closed) valve is required, a 30VM or 60VM valve with a heavy duty air operator can be used.

Note: See main catalog for complete sizing information.



60VM4882-0M
Air to Open
Diaphragm Activated







Air to Open: Actuator Selection Guide

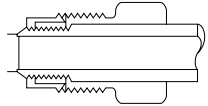
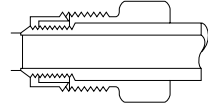
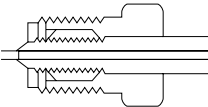







Valve Series	O.D. Tube in. (mm)	Medium		Heavy		Extra Heavy Single Stage		Extra Heavy Two Stage	
		System Pressure psi (bar)	Air Pressure psi (bar)	System Pressure psi (bar)	Air Pressure psi (bar)	System Pressure psi (bar)	Air Pressure psi (bar)	System Pressure psi (bar)	Air Pressure psi (bar)
10SM	9/16 (14.30)	7,900 (545)	95 (6.6)	10,000 (690)	75 (5.1)	10,000 (690)	60 (4.13)	10,000 (690)	40 (2.8)
	3/4 (19.10)	-	-	-	-	10,000 (690)	95 (6.6)	10,000 (690)	60 (4.1)
	1 (25.40)	-	-	-	-	6,500 (448)	100 (6.90)	10,000 (690)	85 (5.9)
20SM	1/4 (6.35)	20,000 (1380)	95 (6.6)	20,000 (1380)	50 (3.4)	-	-	-	-
	3/8 (9.53)	18,250 (1258)	95 (6.6)	18,250 (1258)	50 (3.4)	-	-	-	-
	9/16 (14.30)	9,800 (676)	95 (6.6)	15,700 (1082)	75 (5.1)	20,000 (1380)	85 (5.86)	20,000 (1380)	55 (3.8)
	3/4 (19.10)	-	-	6,000 (414)	75 (5.1)	15,000 (1034)	100 (6.90)	20,000 (1380)	80 (5.5)
	1 (25.40)	-	-	4,000 (276)	75 (5.1)	10,000 (690)	100 (6.90)	20,000 (1380)	100 (6.9)
30SC	1 (25.40)	-	-	-	-	-	-	30,000 (2068)	100 (6.9)
30VM	1/4 (6.35)	30,000 (2068)	75 (5.2)	30,000 (2068)	40 (2.8)	-	-	-	-
	3/8 (9.53)	30,000 (2068)	95 (6.6)	30,000 (2068)	50 (3.5)	-	-	-	-
	9/16 (14.30)	30,000 (2068)	95 (6.6)	30,000 (2068)	50 (3.5)	-	-	-	-
40VM	9/16 (14.30)	40,000 (2758)	100 (6.9)	40,000 (2758)	55 (3.8)	-	-	-	-
60VM	1/4 (6.35)	60,000 (4137)	95 (6.6)	60,000 (4137)	50 (3.5)	-	-	-	-
	3/8 (9.53)	60,000 (4137)	95 (6.6)	60,000 (4137)	50 (3.5)	-	-	-	-
	9/16 (14.30)	60,000 (4137)	95 (6.6)	60,000 (4137)	50 (3.5)	-	-	-	-

Note: Actuator Selection Guide (choose actuator based on available air pressure)

Fittings, Components & Accessories

	Connection Sizes in. (mm)	Pressure Rating psi (bar)	Connection Type	
Medium Pressure	1/4 to 1-1/2 (6.35 to 25.4)	to 20,000 (1380)	Coned-and-threaded type for high strength and repeated make-up. Anti-Vibration collet gland available in line collar and gland to minimize block thickness	
High Pressure	1 (25.4)	to 43,000 (2964)	Coned-and-threaded type for high strength and repeated make-up. Anti-vibration collet gland available.	
	1/4 to 9/16 (6.35 to 14.3)	to 60,000 (4140)	Coned-and-threaded type for high strength and repeated make-up. Anti-vibration collet gland available. Nested collar and gland to minimize block width.	

								
	O.D. Tube Size in. (mm)	Pressure Rating psi (bar)	Elbow	Tee	Cross	Straight Coupling	Union Coupling	Bulkhead Coupling
Medium Pressure	1/4 (6.35)	20,000 (1380)	CLX4400	CTX4440	CXX4444	20FX4466	20UFX4466	20BFX4466
	3/8 (9.53)	20,000 (1380)	CLX6600	CTX6660	CXX6666	20FX6666	20UFX6666	20BFX6666
	9/16 (14.3)	20,000 (1380)	CLX9900	CTX9990	CXX9999	20FX9966	20UFX9966	20BFX9966
	3/4 (19.1)	20,000 (1380)	CLX12	CTX12	CXX12	20FX12	20UFX12	20BFX12
	1 (25.4)	20,000 (1380)	CLX16	CTX16	CXX16	20FX16	20UFX16	20BFX16
	1-1/2 (38.1)	15,000 (1034)	CLX24	CTX24	CXX24	15FX24	15UFX24	15BFX24
High Pressure	1 (25.4)	43,000 (2964)	43CL16	43CT16	43CX16	43F16	43UF16	43BF16
	9/16 (14.3)	40,000 (2760)	40CL9900	40CT9990	40CX9999	40F9933	40UF9933	40BF9933
	1/4 (6.35)	60,000 (4140)	CL4400	CT4440	CX4444	60F4433	60UF4433	60BF4433
	3/8 (9.53)	60,000 (4140)	CL6600	CT6660	CX6666	60F6633	60UF6633	60BF6633
	9/16 (14.3)	60,000 (4140)	CL9900	CT9990	CX9999	60F9933	60UF9933	60BF9933

			Connection Components			Check Valves			Line Filters		Safety Heads
											
	O.D. Tube Size in. (mm)	Pressure Rating psi (bar)	Gland	Collar	Plug	O-Ring	Ball	Excess Flow	Dual Disc	Cup Type	Safety Heads
Medium Pressure	1/4 (6.35)	20,000 (1380)	CGLX40	CCLX40	CPX40	CXO4400	CXB4400	CXK4402	-	CXF4	CSX4600*
	3/8 (9.53)	20,000 (1380)	CGLX60	CCLX60	CPX60	CXO6600	CXB6602	CXK6602	-	CXF6	CSX6600*
	9/16 (14.3)	20,000 (1380)	CGLX90	CCLX90	CPX90	CXO9900	CXB9900	CXK9902	CLFX9900	CXF9	CSX9600*
	3/4 (19.1)	20,000 (1380)	CGLX120	CCLX120	CPX120	CXO12	CXB12	CXK1202	-	CXF12	-
	1 (25.4)	20,000 (1380)	CGLX160	CCLX160	CPX160	CXO16	CXB16	CXK1602	-	CXF16	-
	1-1/2 (38.1)	15,000 (1034)	CGLX240	CCLX240	CPX240	CXO240	CXB240	-	-	-	-
High Pressure	1 (25.4)	43,000 (2964)	CGLX160	CCLX160	43CP160	43CO16	43CB16	-	-	-	-
	9/16 (14.3)	40,000 (2760)	AGL90	ACL90	AP90	-	-	-	-	-	-
	1/4 (6.35)	60,000 (4140)	AGL40	ACL40	AP40	CKO4400	CB4401	CK4402	CLF4400	CF4	CS4600*
	3/8 (9.53)	60,000 (4140)	AGL60	ACL60	AP60	CKO6600	CB6601	CK6602	CLF6600	CF6	CS6600*
	9/16 (14.3)	60,000 (4140)	AGL90	ACL90	AP90	CKO9900	CB9901	CK9902	CLF9900	CF9	CS9600*

* Note: See main catalog for complete model number.

Tubing

Parker Autoclave Engineers offer a complete selection of Austenitic, cold drawn stainless steel tubing designed to match the performance standards of Parker Autoclave Engineers valves and fittings. PAE tubing is manufactured specifically for medium and high pressure applications requiring both strength and corrosion resistance. The tubing is furnished in random lengths between 20 and 26.5 feet (6.1 and 8.0 meter).

Inspection and Testing

Parker Autoclave Engineers tubing is inspected to assure it will be free of seams, laps, fissures or other flaws, as well as carburization or intergranular carbide precipitation. The outside and inside diameters of the tubing are subject to special inspection and are controlled within close tolerances to assure proper fit. Sample pieces of tube for each lot are tested to confirm mechanical properties. Hydrostatic testing is also performed on a statistical basis and is conducted at the working pressure of the tube. Parker Autoclave Engineers will perform 100% hydrostatic testing or autofrettage for high cyclic applications at an additional cost if desired.

Catalog Number	Tube Material	Fits Connection Type	Tube Size in (mm)		Wall Thickness Nom. in (mm)	Flow Area in ² (mm ²)	Working Pressure psi (bar)				
			O.D. in (mm)	I.D. in (mm)			-325 to 100°F (-198 to 38°C)	200°F (93°C)	400°F (204°C)	600°F (316°C)	800°F (427°C)
MS15-092	316SS	SF250CX	1/4 (6.35)	.109 (2.77)	.070 (1.78)	.009 (5.81)	20,000 (1380)	20,000 (1380)	19,250 (1330)	18,050 (1250)	16,800 (1160)
MS15-192	304SS						20,000 (1380)	18,950 (1310)	17,200 (1190)	17,000 (1170)	16,150 (1110)
MS15-093	316SS	SF375CX	3/8 (9.53)	.203 (5.16)	.086 (2.18)	.032 (20.6)	20,000 (1380)	20,000 (1380)	19,250 (1330)	18,050 (1250)	16,800 (1160)
MS15-193	304SS						20,000 (1380)	20,000 (1380)	19,250 (1330)	18,050 (1250)	16,800 (1160)
MS15-085	316SS	SF562CX	9/16 (14.3)	.312 (7.92)	.125 (3.17)	.076 (49)	20,000 (1380)	20,000 (1380)	19,250 (1330)	18,050 (1250)	16,800 (1160)
MS15-187	304SS						20,000 (1380)	20,000 (1380)	19,250 (1330)	18,050 (1250)	16,800 (1160)
MS15-097	316SS	SF562CX	9/16 (14.3)	.359 (9.12)	.101 (2.56)	.101 (65.2)	15,000 (1034)	15,000 (1034)	14,400 (992)	13,650 (941)	12,670 (874)
MS15-194	304SS						15,000 (1034)	14,170 (977)	12,900 (890)	12,750 (880)	12,670 (874)
MS15-095	316SS	SF750CX	3/4 (19.1)	.438 (11.1)	.156 (3.96)	.151 (97.4)	20,000 (1380)	20,000 (1380)	19,250 (1330)	18,050 (1250)	16,800 (1160)
MS15-098	316SS			.516 (13.1)	.117 (2.97)	.209 (135)	15,000 (1034)	15,000 (1034)	14,400 (993)	13,650 (941)	12,670 (874)
MS15-096	316SS	SF1000CX	1 (25.4)	.562 (14.3)	.219 (5.56)	.248 (160)	20,000 (1380)	20,000 (1380)	19,250 (1330)	18,050 (1250)	12,670 (874)
MS15-099	316SS			.688 (17.5)	.156 (4.02)	.371 (239)	15,000 (1034)	15,000 (1034)	14,400 (993)	13,650 (941)	12,670 (874)
13041	316SS	SF1500CX	1-1/2 (38.1)	.937 (23.8)	.281 (7.14)	.589 (444.8)	15,000 (1034)	15,000 (1034)	14,430 (995)	13,530 (932)	12,600 (868)
MS15-081	316SS	F250C	1/4 (6.35)	.083 (2.11)	.083 (2.11)	.005 (3.22)	60,000 (4140)	60,000 (4140)	57,750 (3980)	54,250 (3740)	50,700 (3490)
MS15-182	304SS						60,000 (4140)	56,800 (3910)	51,650 (3560)	50,700 (3500)	48,450 (3340)
MS15-087	316SS	F375C	3/8 (9.53)	.125 (3.18)	.125 (3.18)	.012 (7.74)	60,000 (4140)	60,000 (4140)	57,750 (3980)	54,250 (3740)	50,700 (3490)
MS15-183	304SS						60,000 (4140)	56,800 (3910)	51,650 (3560)	50,700 (3500)	48,450 (3340)
MS15-090	316SS	F562C40	9/16 (14.3)	.25 (6.35)	.156 (4.02)	.048 (31)	40,000 (2760)	40,000 (2760)	38,500 (2655)	36,100 (2489)	33,800 (2330)
MS15-083	316SS	F562C	9/16 (14.3)	.187 (4.78)	.187 (4.78)	.028 (18)	60,000 (4140)	60,000 (4140)	57,750 (3980)	54,250 (3740)	50,700 (3490)
MS15-185	304SS						60,000 (4140)	56,800 (3910)	51,650 (3560)	50,700 (3500)	48,450 (3340)
MS15-211	316SS	-	1 (25.4)	.438 (11.1)	.281 (7.14)	.151 (97.4)	43,000 (2964)	43,000 (2964)	43,000 (2964)	41,380 (2853)	36,330 (2504)

Note: For autofrettage tubing, add suffix "ESR42" to the tubing part number.

Coned and Threaded Nipples

For rapid system make-up, Parker Autoclave Engineers supplies pre-cut, coned-and-threaded nipples in various sizes and lengths for Parker Autoclave Engineers valves and fittings.

Special lengths

In addition to the standard lengths listed in the table below, nipples are available in any custom length. Consult factory.

Materials

Catalog numbers in table refer to Type 316 stainless steel, unless specified.

Working Fits Connection Type	Tube Size in (mm)		Pressure at 100°F (38°C) psi (bar)	Catalog Number						
	O.D.	I.D.		2.75" Length	3" Length	4" Length	6" Length	8" Length	10" Length	12" Length
SF250CX	1/4 (6.35)	.109 (2.77)	20,000 (1380)	CNX4402	CNX4403	CNX4404	CNX4406	CNX4408	CNX44010	CNX44012
SF375CX	3/8 (9.53)	.203 (5.16)	20,000 (1380)		CNX6603	CNX6604	CNX6606	CNX6608	CNX66010	CNX66012
SF562CX	9/16 (14.3)	.312 (7.92)	20,000 (1380)			CNX9904	CNX9906	CNX9908	CNX99010	CNX99012
SF562CX	9/16 (14.3)	.359 (9.12)	15,000 (1034)			CNLX9904	CNLX9906	CNLX9908	CNLX99010	CNLX99012
SF750CX	3/4 (19.1)	.438 (11.1)	20,000 (1380)			CNX1204	CNX1206	CNX1208	CNX12010	CNX12012
SF750CX	3/4 (19.1)	.515 (13.1)	15,000 (1034)			CNLX1204	CNLX1206	CNLX1208	CNLX12010	CNLX12012
SF1000CX	1 (25.4)	.562 (14.3)	20,000 (1380)				CNX1606	CNX1608	CNX16010	CNX16012
SF1000CX	1 (25.4)	.688 (17.5)	15,000 (1034)				CNLX1606	CNLX1608	CNLX16010	CNLX16012
SF1500CX	1-1/2 (38.1)	.937 (23.79)	15,000 (1034)				CNLX2406 *	CNLX2408 *	CNLX24010 *	CNLX24012 *
F250C	1/4 (6.35)	.083 (2.11)	60,000 (4140)	CN4402	CN4403	CN4404	CN4406	CN4408	CN44010	CN44012
F375C	3/8 (9.53)	.125 (3.18)	60,000 (4140)		CN6603	CN6604	CN6606	CN6608	CN66010	CN66012
F562C	9/16 (14.3)	.187 (4.78)	60,000 (4140)			CN9904	CN9906	CN9908	CN99010	CN99012
F562C40	9/16 (14.3)	.250 (6.35)	40,000 (2760)			40CN9904 *	40CN9906 *	40CN9908 *	40CN99010 *	40CN99012 *
F1000C43	1 (25.4)	.438 (11.1)	43,000 (2964)				43CN1606	43CN1608	43CN16010	43CN16012

Note: * only available in 316 material



Anti Vibration Collet Gland Assemblies

Vibration and/or shock can be present in tubing systems, especially if the valve or fitting happens to be located on an unsupported line near a compressor or pump. For this reason, Parker Autoclave Engineers coned-and-threaded connections are offered with the Parker Autoclave Engineers Anti-Vibration Collet Gland Assemblies. Completely interchangeable with standard Parker Autoclave Engineers high pressure connections, the Collet Gland Assemblies provide equally effective pressure handling capability.

O.D. Tubing Size in (mm)	Catalog Number	
	Medium Pressure to 20,000	High Pressure to 60,000
1/4 (6.35)	KCBGLX40-316MC	KCGL40-316
3/8 (9.53)	KCBGLX60-316MC	KCGL60-316
9/16 (14.3)	KCBGLX90-316MC	KCGL90-316
3/4 (19.1)	KCBGLX120-316MC	-
1 (25.4)	KCBGLX160-316MC	+KCBGLX160-316MC
1-1/2 (38.1)	KCBGLX240-316MC	-

+ 1" High Pressure to 43,000 psi (2964 bar)

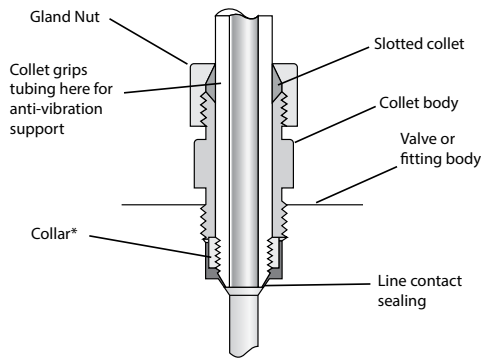

Series KCBGLX
Pressures to 20,000 psi (1380 bar)

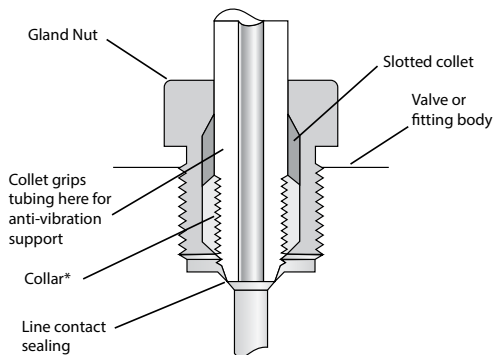

Series KCGL
Pressures to 60,000 psi (1440 bar)

* Collar not included in complete assembly.



Male/Female Adapters

Male/female adapters are designed to adapt a female connection direct to another size and/or type of connection. In selecting an adapter involving two different sized connections, the larger connection should be on the male end where it is possible to maximize the mechanical strength of the adapter. See valve fitting and tubing catalog for complete selection.

How to use the Ordering Chart:

1. Locate MALE end in the vertical column.
2. Locate desired FEMALE end of adapter across top of chart.
3. The catalog number of the required adapter is located at the intersection of the two columns.



FEMALE END ►			P-AE Medium Pressure						P-AE High Pressure					
			1/4 (6.35) SF250CX	3/8 (9.53) SF375CX	9/16 (14.3) SF562CX	3/4 (19.1) SF750CX	1 (25.4) SF1000CX	1-1/2 (38.1) SF1500CX	1 (25.4) F1000C43	1/4 (6.35) F250C	3/8 (9.53) F375C	9/16 (14.3) F562C	9/16 (14.3) F562C40	
MALE END ▼	Fits this FEMALE Connection	Press. psi* (bar)	20,000 (1380)	20,000 (1380)	20,000 (1380)	20,000 (1380)	20,000 (1380)	15,000 (1034)	43,000 (2964)	60,000 (4140)	60,000 (4140)	60,000 (4140)	40,000 (2758)	
P-AE Medium Pressure	1/4 (6.35)	SF250CX	20,000 (1380)		20M46K6	20M49K6	20M412K6	20M416K6	15M424K6		20M44K3	20M46K3	20M49K3	
	3/8 (9.53)	SF375CX	20,000 (1380)	20M64K6		20M69K6	20M612K6	20M616K6			20M64K3	20M66K3	20M69K3	
	9/16 (14.3)	SF562CX	20,000 (1380)	20M94K6	20M96K6		20M912K6	20M916K6	15M924K6		20M94K3	20M96K3	20M99K3	
	3/4 (19.1)	SF750CX	20,000 (1380)	20M124K6	20M126K6	20M129K6		20M1216K6	15M1224K6	20M1216K3	20M124K3	20M126K3	20M129K3	20M129K40
	1 (25.4)	SF1000CX	20,000 (1380)	20M164K6	20M166K6	20M169K6	20M1612K6	20M1616K6	15M1624K6		20M164K3	20M166K3	20M169K3	
	1-1/2 (38.1)	SF1500CX	15,000 (1034)	15M244K6		15M249K6	15M2412K6	15M2416K6	15M2424K6					
P-AE High Pressure	1 (25.4)	F1000C43	43,000 (2964)						15M1624B6		43M164B3	43M166B3	43M169B3	43M169B40
	1/4 (6.35)	F250C	60,000 (4140)	20M44B6	20M46B6	20M49B6	20M412B6		15M424B6			60M46B3	60M49B3	
	3/8 (9.53)	F375C	60,000 (4140)	20M64B6	20M66B6	20M69B6	20M612B6	20M616B6		43M416B6	60M64B3		60M69B3	
	9/16 (14.3)	F562C	60,000 (4140)	20M94B6	20M96B6	20M99B6	20M912B6	20M916B6		43M616B6	60M94B3	60M96B3		
	9/16 (14.3)	F562C40	40,000 (2758)				20M912G6			43M916B6				

* Pressure Rating - The pressure rating of Parker Autoclave Engineers couplings is based on the lower rated connection used.

Other Adapters

Parker Autoclave Engineers supplies many other types of adapters on special orders. These include NPT, Butt weld, Socket weld, QSS, Ez-Union, Male SAE-Oring, JIC connections and others.

Materials

All Parker Autoclave Engineers adapters are precision machined from cold-worked Type 316 stainless steel. Other materials available on special order.

Adapter Couplings

The couplings shown here permit the joining of any combination of standard size Parker Autoclave Engineers tubing with female-to-female couplings. Other couplings available on special order. See valve fitting and tubing catalog for complete selection.

How to use the Ordering Chart:

1. Locate "A" connection in the vertical column.
2. Locate the desired "B" connection across the top of the chart.
3. The catalog number of the required coupling is located at the intersection of the two columns.

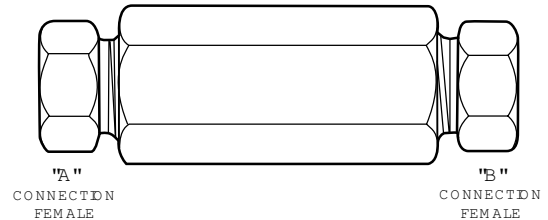

"A" Connection				"B" Connection										
				P-AE Medium Pressure						P-AE High Pressure				
Tube Size in (mm)	Connection Type	Press. psi* (bar)	1/4 (6.35)	3/8 (9.53)	9/16 (14.3)	3/4 (19.1)	1 (25.4)	1-1/2 (38.1)	1 (25.4)	1/4 (6.35)	3/8 (9.53)	9/16 (14.3)	9/16 (14.3)	
			SF250CX	SF375CX	SF562CX	SF750CX	SF1000CX	SF1500CX	F1000C43	F250C	F375C	F562C	F562C40	
P-AE Medium Pressure	1/4 (6.35)	SF250CX	20,000 (1380)	20FX4466	20F4666	20F4966	20F41266	20F41666	15FX42466	20F41663	20F4463	20F4663	20F4963	
	3/8 (9.53)	SF375CX	20,000 (1380)		20FX6666	20F6966	20F61266	20F61666		20F61663	20F6463	20F6663	20F6963	
	9/16 (14.3)	SF562CX	20,000 (1380)			20FX9966	20F91266	20F91666	15FX92466		20F9463	20F9663	20F9963	
	3/4 (19.1)	SF750CX	20,000 (1380)				20FX12	20F121666			20F12463	20F12663	20F12963	
	1 (25.4)	SF1000CX	20,000 (1380)					20FX16			20F16463	20F16663	20F16963	
	1-1/2 (38.1)	SF1500CX	15,000 (1034)						15FX24					
P-AE High Pressure	1 (25.4)	F1000C43	43,000 (2964)							43F16				
	1/4 (6.35)	F250C	60,000 (4140)							43F41633	60F4433	60F4633	60F4933	
	3/8 (9.53)	F375C	60,000 (4140)							43F61633		60F6633	60F6933	
	9/16 (14.3)	F562C	60,000 (4140)							43F91633			60F9933	
	9/16 (14.3)	F562C	40,000 (2758)											40F9933



Ball Valves

High Pressure

Parker Autoclave Engineers Ball Valves are designed for on-off, high flow, high pressure applications and provide superior quality with maximum performance. Our unique one-piece trunnion mounted stem/ball eliminates the shear failure common in two-piece designs. Our re-torqueable seat glands result in longer seat life and our low friction stem seal reduces actuation torque and enhances cycle life.

Parker Autoclave Engineers ball valves can be operated safely up to 20,000 psi and up to 400°F (204°C), and up to 500°F with the high temperature option. 2-way, 3-way & 4-Way Switching & Crossover styles are available.



Order Matrix:

2B	4	S	20	M	4	-	
Valve Series	Ball Orifice	Material	Maximum Rated Pressure x1000 ¹	End Connection Type ²	End Connection Size		Options
2B = 2 Way 3B = 3 Way 3BD = 3 Way Diverter 4B = 4 way Crossover 4BS = 4 Way Switching	3 = 3/16" 4 = 1/4" 6 = 3/8" 8 = 1/2" 12 = 3/4" 16 = 1"	S = 316 SS for other options contact factory	5 10 15 20	L = Low Pressure M = Medium Pressure H = High Pressure P = NPT	2 = 1/8" 4 = 1/4" 6 = 3/8" 8 = 1/2" 9 = 9/16" 12 = 3/4" 1 = 1"		HT = High Temp. AO = Air to Open AC = Ait to Close AOC = Ait to Open/Close E01 = Electric 120VAC E02 = Electric 220VAC E03 = Electric 240VAC

Note: Matrix can build valves not yet available, refer to main catalog for exact size/valve series selection

1 = Pressure chosen after considering orifice size, connection and temperature requirements - see main catalog for all available operations.

2 = Low Pressure connection sizes 1/8" through 1/2", Medium and High Pressure connections not available in 1/8" or 1/2"

Double Block and Bleed Ball Valves

Parker Autoclave Engineers series 6DB Double Block Valve is a 2-stem ball valve combined with a separate needle valve that provides a convenient method of blocking and bleeding an instrument injection port, gauge, or provides drain line isolation, decreasing leak points and reducing overall weight. This full port quarter turn double ball valve is designed for operation up to 15,000 psi (1034 bar).



Subsea Series Ball Valves

Parker Autoclave Engineers subsea ball valves have been designed to fulfill the ever growing demand by the Petroleum Industry for externally pressurized components. Utilizing the proven technologies that make our ball valve "best in class", we've incorporated the necessary design features to provide a reliable externally pressurized valve for the subsea industry and simplified the mounting for ROV, diver, or remote actuation capabilities. Our 2-way and 3-way Subsea Series valves are able to withstand up to 20,000 psi (1380 bar) internal pressures at up to 12,500' (3810 meters) water depth.



Instrument Quality Gauges

Materials and Features

- Accuracy within $\pm 0.5\%$ of full scale range
- Plastic dial cover/solid front aluminum alloy case
- Blow-out back panel for pressure relief in the event of Bourdon tube failure
- 316 Stainless steel Bourdon tubes**
- Precision stainless steel movement for accuracy and resistance to atmospheric corrosion
- Pointer zero adjustment located on front of gauge behind dial cover for convenience

Instrument quality gauges

- Flush panel mounting - Panel mounting kits are stocked to permit flush panel mounting of any instrument quality gauge. These will be furnished at an additional charge when specified on order -- add "PM" to order number.
- Optional electrical contact face - Available for all instrument quality gauges. With adjustable low and high electrical contacts, this option permits gauges to provide pressure control for automatic or remote operation, or for fail-safe set points.

** Bourdon Tube material for 0-80,000 psi (0-5116 bar) and 0-50,000 psi (0-3447 bar) gauge is Inconel 718.
Bourdon Tube material for 0-30,000 psi (0-2068 bar) gauge is K Monel.

Calibrated in psi Only			
Catalog Number	Pressure Range (psi)	Minor Interval Value (psi)	Dial Diameter (inches)
P-0499-CG	0-1000	10	4-1/2"
P-0479-CG	0-1500	10	4-1/2"
P-0480-CG	0-3000	20	4-1/2"
P-0481-CG	0-5000	50	4-1/2"
P-0482-CG	0-10,000	100	4-1/2"
P-0483-CG	0-15,000	100	4-1/2"
P-0487-CG	0-20,000	200	4-1/2"
P-0488-CG**	0-30,000	200	6"
P-0489-CG**	0-50,000	500	6"
P-0490-CG**	0-80,000	1,000	6"

Optional Electrical Contact Face	
Catalog Number	Fits Gauges Dial Diameter (inches)
P-0713	4-1/2"
P-0714	6"

Note: Gauges available with back connections. Add B to the base catalog number. Ex: P-047B-CG 1/4" (F250C) Coned-and-Threaded Connection Furnished with Collar and Gland



Manifolds and Relief Valves

Manifold Blocks

Specialty pressure manifolds minimize space requirements and reduce installation time necessary to plumb a pressure system. In addition, by reducing the number of components used in a system, manifolds reduce the number of potential leak joints.



Parker Autoclave Engineers will design and build pressure manifolds to meet specific installation, layout and pressure requirements. These manifolds are capable of withstanding pressures from vacuum to 60,000 psi (4137 bar), and are available in a variety of materials and sizes. Among the pressure connections that can be incorporated are Parker Autoclave Engineers' low, medium and high pressure, NPT, SAE, BSP and others. Transitions in system line sizes and tubing pressure series can be accomplished through a specialty manifold. These manifolds are appropriate wherever pressure tubing systems are utilized.

Relief Valves: RVP-Metal Seat and RVS-Soft Seat Series

Series RVP & RVS relief valves provide reliable venting of gases or liquids for set pressures from 1,500 psi (103 bar) to 60,000 psi (4140 bar). Standard temperature range on RVP models is -423° F to 400° F (-253° C to 204° C). High temperature option to 750° F (400° C) also available. Temperature range on RVS model is 32° F to 400° F (0° C to 204° C). (Note: Seat material is Arlon).

These precision valves are designed for pressure gas systems, cryogenic systems, petrochemical applications and other special systems. They are capable of handling air, gases, steam, vapor and liquids. They are not recommended for steam boiler applications and are not ASME code stampable.

Relief valves are designed to open proportionally to increasing back pressure and, therefore, are not recommended for applications requiring immediate full valve flow at set pressure (such as decompositions, polymerizations, etc.). Full flow of relief valve is defined at 10% over set pressure.



Catalog Number	Connection Size & Type (inches)			Pressure Rating PSIG @ 100°F (bar @ 38°C)		
	Inlet	Outlet FNPT	Orifice in (mm)	Minimum Set	Maximum Set	Maximum Back
5RVP9072	SF562CX	3/4 (19.1)	.312 (7.92)	3,000 (207)	5,000 (345)	500 (34.5)
10RVP9072	SF562CX	3/4 (19.1)	.250 (6.35)	5,000 (345)	10,000 (690)	500 (34.5)
15RVP9072	SF562CX	3/4 (19.1)	.188 (4.78)	10,000 (689)	15,000 (1034)	500 (34.5)
20RVP9072	SF562CX	3/4 (19.1)	.156 (4.02)	15,000 (1034)	20,000 (1379)	500 (34.5)
30RVP6072	F375C	3/4 (19.1)	.125 (3.18)	20,000 (1379)	30,000 (2068)	500 (34.5)
45RVP9072	F562C	3/4 (19.1)	.093 (2.36)	25,000 (1724)	45,000 (3103)	500 (34.5)
60RVP6072	F375C	3/4 (19.1)	.078 (1.98)	30,000 (2060)	60,000 (4137)	500 (34.5)
Soft Seat						
5RVS9072	SF562CX	3/4 (19.1)	.312 (7.92)	1,500 (103)	5,000 (345)	500 (34.5)
10RVS9072	SF562CX	3/4 (19.1)	.250 (6.35)	5,000 (345)	10,000 (690)	500 (34.5)
20RVS9072	SF562CX	3/4 (19.1)	.156 (4.02)	10,000 (690)	20,000 (1379)	500 (34.5)

Tools

Manual Coning and Threading Tools

Parker Autoclave Engineers manufactures a manual coning tool for optimum coning performance with tubing sizes up to 9/16" (14.3 mm) O.D. This is a precision quality manual tool to permit on-site end preparation for AE medium and high pressure tubing installations. Interchangeable collets for each size tubing provide proper centering of tubing. The cutting feed arrangement permits the operator to control the depth of cut to assure against work hardening effects. Interchangeable tool steel cutting blades are used in pairs to assure more accurate and faster coning and are designed to square-off and finish the tube as the cone is completed. There is a provision for applying metal cutting lubricants to the cutting zone.



The threading die holder is designed to hold the appropriate die for any of the standard Parker Autoclave Engineers tubing sizes through 9/16" (14.3 mm) O.D. Interchangeable guide bushings properly guide the tool for accurate thread cutting.

Note: Complete tool kits are available. Consult factory



Threading Tool

* For coning tool with optional Vice Arm and Oil/Chip Reservoir, add RS suffix to model number. Ex: MCTM4-RS

	Tube Size		Coning Tools and Components Catalog Number			Threading Tools and Components Catalog Number				
	O.D. in (mm)	I.D. in (mm)	Tool with Collet & Blades	Collet	Coning Blades (Set of 2)	Tool with Die & Bushing	Tool Only	Threading Die		Guide Bushing
	Order No.	Size-type*								
PAE Medium Pressure	1/4 (6.35)	.109 (2.77)	MCTM4	90248	101F-1577	402A	402	P-0214	1/4-28	1010-0343
	3/8 (9.53)	.203 (5.16)	MCTM6	90250	101F-1601	402C	402	P-0215	3/8-24	1010-0344
	9/16 (14.3)	.312 (7.92)	MCTM920	90251	1010-5218	402E	402	P-0216	9/16-18	1010-0345
	9/16 (14.3)	.359 (9.12)	MCTM910	90251	101A-1897	402E	402	P-0216	9/16-18	1010-0345
PAE High Pressure	1/4 (6.35)	.083 (2.11)	MCTH4	90248	101F-3939	402A	402	P-0214	1/4-28	1010-0343
	3/8 (9.53)	.125 (3.18)	MCTH6	90250	101F-1578	402C	402	P-0215	3/8-24	1010-0344
	9/16 (14.3)	.188 (4.78)	MCTH960	90251	1010-0883	402E	402	P-0216	9/16-18	1010-0345
	9/16 (14.3)	.250 (6.35)	MCTH940	90251	101C-7214	402E	402	P-0216	9/16-18	1010-0345

Cutting Oil: P-8784

• All threads for PAE medium pressure and high pressure tubing are LH national fine (class 2).

Note: Manual coning and threading tools for 3/4" (19.1 mm) and 1" (25.4 mm) O.D. medium pressure tubing are not available. Model AEGCTM-2 Power

Coning-and-Threading Machine is recommended for this tubing. A minimum of 3" (76 mm) straight length is required to perform coning and threading operation for manual coning tool.

Tools

P-AE Micrometer Adjustable Torque Wrench

P-1680 20 to 150 ft. lbs. (27 to 203 Nm)

91020 75 to 250 ft. lbs. (102 to 339 Nm)

Accurate tightening for all Parker Autoclave Engineers valve packing glands and tube nuts is essential. The wrench can be adjusted to the ranges shown and is used with interchangeable wrench adapters for hex sizes from 1/2" through 1-7/8". Part numbers for wrench adapters are listed on chart.



Packing Gland or Tube Nut Hex Size in (mm)	1/2 (12.7)	9/16 (14.3)	5/8 (15.9)	3/4 (19.05)	13/16 (20.6)	7/8 (22.2)	15/16 (23.8)	1 (25.4)	1-1/16 (27)	1-3/16 (30.2)	1-3/8 (34.9)	1-1/2 (38.1)	1-7/8 (47.6)
Wrench Adapter Number	P-1681	P-1682	P-1683	P-9813	P-1685	P-1686	P-1687	P-9901	P-1688	P-1689	P-1690	P-6040	P-10076

Hydraulic Tube Bender

For single pass bending of high pressure tubing. The Parker Autoclave Engineers hydraulic tube bender is designed to bend heavy wall tubing quickly, accurately and reliably with only one setup. The tube bender is complete with pump, cylinder, frame and bending shoes which are self-contained in a portable, lockable case. (Order number: HTB)



Air operated hydraulic pump option available in place of hand pump. (Order Number: HTB-A)

Coning and Threading Machine

Ordering Procedure: Model # AEGCTM-2 (CE Version: Model #AEGCTM-2E-CE)

Separate heads for coning and threading are powered by a single motor and drive system. Available models cone and thread Parker Autoclave Engineers medium and high pressure tubing.

Approximate dimensions: 56" high, 28" wide and 20" deep (1.4 m x .7 m x .5 m). Shipping weight is 350 pounds (159 kg). Tooling ordered separately. Consult factory.

Features

- One-half hp motor, 115 VAC 60 Hz (220 VAC 50 Hz) volt capacitor start.
- No reversing necessary on threading operation; pop-open die prevents thread damage.
- Complete tooling is available; specify tooling sizes required.
- Coning head has feed wheel for easy, precision feeding.
- Complete with oil pump and reservoir.
- Unit mounted on stand complete with locking casters for ease of mobility and stability.
- Available with optional reservoir heater
- CE mark standard on 220 VAC 50 Hz models



Connections

P-AE Medium Pressure SFCX

Tube O.D. in (mm)	Connection Type	Dimensions inches (mm)					
		A	B	C	D	F	H
1/4 (6.35)	SF250CX20	25/64	7/16 -20	.28 (7.11)	.50 (12.7)	.19 (4.83)	.109 (2.77)
3/8 (9.53)	SF375CX20	33/64	9/16 -18	.38 (9.65)	.62 (15.7)	.31 (7.87)	.203 (5.16)
9/16 (14.3)	SF562CX10* SF562CX20	3/4	13/16 -16	.44 (11.2)	.75 (19.1)	.50 (12.7)	.359 (9.12) .312 (7.9)
3/4 (19.1)	SF750CX10* SF750CX20	61/64 ¹	3/4 -14	.50 (12.7)	.94 (23.9)	.62 (15.7)	.516 (13.1) .438 (11.1)
1 (25.4)	SF1000CX10* SF1000CX20	1-19/64	1-3/8 -12	.81 (20.6)	1.31 (33.3)	.88 (22.4)	.688 (17.5) .562 (14.3)
1-1/2 (38.1)	SF1500CX	1-51/64	1-7/8 -12	1.00 (25.4)	1.59 (40.5)	1.375 (34.9)	.937 (23.8)

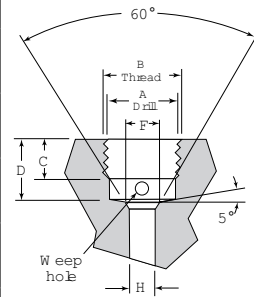

Note: ¹ = NPS Male Tap

* Connection used in fittings rated for 20,000 psi (1379)

P-AE High Pressure FC

Tube O.D. in (mm)	Connection Type	Dimensions inches (mm)					
		A	B	C	D	F	H
1/4 (6.35)	F250C	33/64	9/16 -18	.38 (9.65)	.44 (11.2)	.17 (4.32)	.094 (2.39)
3/8 (9.53)	F375C	11/16	3/4 -16	.53 (13.5)	.62 (15.7)	.26 (6.60)	.125 (3.18)
9/16 (14.3)	F562C	1-3/64	1-1/8 -12	.62 (15.7)	.75 (19.1)	.38 (9.65)	.188 (4.78)
3/4 (19.1)	F562C40	1-3/64	1-1/8 -12	.62 (15.7)	.75 (19.1)	.38 (9.65)	.250 (6.35)
1 (25.4)	F1000C43	1-19/64	1-3/8 -12	.81 (20.6)	1.31 (33.3)	.88 (22.4)	.438 (11.1)

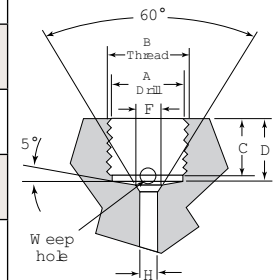

Note: All dimensions are shown for reference only and should not be considered as actual machining dimensions.

For port Diameter please see orifice sizes for specific valves and fittings. All threads are manufactured to a class 2A or 2B fit.



Flow Calculations

Coefficient of flow (C_v) for a valve is the volume of water in U.S. gallons per minute at room temperature...which will flow through the valve with the stem fully open...with a pressure drop of 1 psi across the valve. C_v is the valve sizing factor that permits selection of the appropriate valve to meet the flow requirements of a given fluid system.

The C_v values shown on the valve ordering pages represent the full-open C_v for that valve. In determining estimated capacity, this C_v value should be used in the formulas which follow.

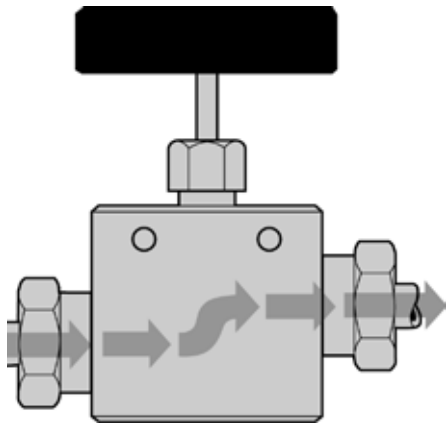

Flow Formulas

Liquids

- Flow, U.S. gal./min.
- Flow, lb./hr.

$$V = \frac{C_v \sqrt{P_1 - P_2}}{\sqrt{S_{GF}}}$$

$$W = 500 C_v \sqrt{(P_1 - P_2)/S_{GF}}$$

Gases

- Flow, SCFH
- Flow, SCFH (temperature corrected)
- Flow, lb./hr.

$$Q = \frac{42.2 C_v \sqrt{(P_1 - P_2)(P_1 + P_2)}}{\sqrt{S_{GF}}}^{**}$$

$$Q = \frac{963 C_v \sqrt{(P_1 - P_2)(P_1 + P_2)}}{\sqrt{S_{GF} T_F}}^*$$

Saturated Steam

- Flow, lb./hr.

$$W = 3.22 C_v \sqrt{(P_1 - P_2)(P_1 + P_2)/S_G}^*$$

Super Heated Steam

- Flow, lb./hr.

$$W = 2.1 C_v \sqrt{(P_1 - P_2)(P_1 + P_2)}^*$$

$$W = \frac{2.1 C_v \sqrt{(P_1 - P_2)(P_1 + P_2)}}{(1 + 0.0007 T_S)}^*$$

Specific gravity (S_g) typical Gases

Gases	S_g @ RT Relative to Air
Acetylene	0.897
Air	1.000
Ammonia	0.587
Argon	1.377
Butane	2.070
Carbon Dioxide	1.516
Ethylene	0.967
Helium	0.138
Hydrogen	0.0695
Methane	0.553
Nitrogen	0.966
Oxygen	1.103
Propane	1.562
Sulphur Dioxide	2.208

Specific gravity (S_{GF}) typical Liquids

Liquids	S_{GF} @ RT Relative to Water
Acetone	0.792
Alcohol	0.792
Benzine	0.902
Gasoline	0.751
Gasoline, nat.	0.680
Kerosene	0.815
Pentane	0.624
Water	1.000

Formula Nomenclature

- V = Flow, U.S. gallons per minute (GPM)
- Q = Flow, standard cu. ft. per hr. (SCFH)
- W = Flow, pounds per hour (lb./hr.)
- P_1 = Inlet pressure, psia (14.7 + psig)
- P_2 = Outlet pressure, psia (14.7 + psig)
- S_{GF} = Liquid specific gravity (water = 1.0)
- S_G = Gas specific gravity (air = 1.0)
- T_F = Flowing temp., °R absolute (460 + °F)
- T_S = Superheat in °F
- C_v = Valve coefficient of flow, full open

* Effect of flowing temperatures on gas flow are minimal for temperatures between 30°F and 150°F. Correction should be included if temperatures are higher or lower.

** Where outlet pressure P_2 is less than $1/2$ inlet pressure P_1 , the term: $\sqrt{(P_1 - P_2)(P_1 + P_2)}$ becomes $0.87 \times P_1$.

Note: Maximum C_v values in this catalog have been determined in accordance with the Fluid Controls Institute report FCI 58-2. "Recommended Voluntary Standards for Measurement Procedure for Determining Control Valve Flow Capacity," including procedure, design of the test stand and evaluation of the data.

Sour Service Products

Parker Autoclave Engineers designs and builds high pressure valves, fittings, and tubing specifically for use with Sour Oil and Gas (H₂S) and meet or exceed all requirements of NACE MRO175-2002 (NACE to current revisions available). Our SOG line of products are manufactured with materials and procedures specified to meet the NACE requirements. Valves and Fittings for standard service are rated for working pressures up to 60,000 psi (4140 bar) at 100°F (38°C). Type SOG components are rated up to 30,000 psi (2068 bar) at 100°F (38°C). Valves are furnished without collars and glands unless otherwise specified.

Note: Refer to main catalog for full product information.



WARNING

FAILURE, IMPROPER SELECTION OR IMPROPER USE OF THE PRODUCTS AND/OR SYSTEMS DESCRIBED HEREIN OR RELATED ITEMS CAN CAUSE DEATH, PERSONAL INJURY AND PROPERTY DAMAGE.

This document and other information from Parker Hannifin Corporation, its subsidiaries and authorized distributors provide product and/or system options for further investigation by users having technical expertise. It is important that you analyze all aspects of your application and review the information concerning the product or system in the current product catalog. Due to the variety of operating conditions and applications for these products or systems, the user, through its own analysis and testing, is solely responsible for making the final selection of the products and systems and assuring that all performance, safety and warning requirements of the application are met. The products described herein, including without limitation, product features, specifications, designs, availability and pricing, are subject to change by Parker Hannifin Corporation and its subsidiaries at any time without notice.

Offer of Sale

The items described in this document are available for sale by Parker Hannifin Corporation, its subsidiaries or its authorized distributors. Any sale contract entered by Parker will be governed by the provisions stated in Parker's standard terms and conditions of sale (copy available upon request).

© 2013 Parker Hannifin Corporation | Autoclave Engineers is a registered trademark of the Parker Hannifin Corporation

Cat 4190/VFT

September 2013

Caution! Do not mix or interchange parts or tubing with those of other manufacturers. Doing so is unsafe and will void warranty.

Caution! Parker Autoclave Engineers Valves, Fittings and Tools are not designed to work with common commercial instrument tubing and will only work with tubing built to Parker Autoclave Engineers AES Specifications. Failure to do so will void warranty.



Parker Hannifin Corporation
Instrumentation Products Division
 Autoclave Engineers Operation
 8325 Hessinger Drive
 Erie, Pennsylvania 16509-4679 USA
 Tel: 814-860-5700 Fax: 814-860-5811

Parker Hannifin Corporation
Instrumentation Products Division
 1005 A Cleaner Way
 Huntsville, AL 35805, USA
 Tel: 1 265 881 2040
 Fax: 1 256 881 5072

Parker Hannifin Manufacturing Ltd.
Instrumentation Products Division, Europe
 Industrial Estate Whitemill
 Wexford, Republic of Ireland
 Tel: 353 53 914 1566
 Fax: 353 53 914 1582

Parker Hannifin Manufacturing Ltd.
Instrumentation Products Division, Europe
 Riverside Road, Pottington Business Park
 Barnstaple, UK, EX31 1NP, UK
 Tel: 44 1271 313131
 Fax: 44 1271 373636