

21 MPa position sensing cylinders using absolute method

- The position sensor applying a magnetostriction phenomenon enables high-accuracy absolute position detection.
- No necessary to adjusting the original position, and position correction is not required.
- Space-saving design and easy to install.



Standard Specifications

Type	General purpose type
Nominal pressure	21 MPa
Maximum allowable pressure	Cap side and rod side (Rod A): 26.5 MPa Rod side (Rod B): 24.5 MPa
Proof test pressure	31.5 MPa
Minimum operating pressure	Cap side: 0.3 MPa or less Rod side: Rod B: 0.45 MPa or less Rod side: Rod A: 0.6 MPa or less
Working speed range	$\phi 50$ to $\phi 63$: 8 to 400mm/s $\phi 80$ to $\phi 125$: 8 to 300mm/s $\phi 140$ to $\phi 160$: 8 to 200mm/s
Working temperature range (ambient temperature)	Standard type -10°C to $+80^{\circ}\text{C}$ (No freezing)
Structure of cushioning	Metal fitting system
Adaptable fluid	Petroleum-based fluid (When using another fluid, refer to the table of fluid adaptability.)
Tolerance for thread	JIS 6g/6H
Tolerance of stroke	0 to 100 mm: $^{+0.8}_0$ 631 to 1000mm: $^{+1.4}_0$ 101 to 250mm: $^{+1.0}_0$ 1001 to 1600mm: $^{+1.6}_0$ 251 to 630mm: $^{+1.25}_0$ 1601 to 2000mm: $^{+1.8}_0$
Mounting style	SD·LA·FA·TA·TC
Rod series	Rod B, rod A
Accessories	Boots Standard: Nylon tarpaulin Semi-standard: Chloroprene or Conex
	Rod end attachments T-end, Y-end (with pin), lock nut

Terminologies

Nominal pressure

Pressure given to a cylinder for convenience of naming.

Maximum allowable pressure

Maximum allowable pressure generated in a cylinder (surge pressure, etc.).

Proof test pressure

Test pressure against which a cylinder can withstand without unreliable performance at the return to nominal pressure.

Minimum operating pressure

Minimum pressure at which cylinder installed horizontally operates under no load.

Notes) • The hydraulic pressure generated in a cylinder due to the inertia of load must be lower than the maximum allowable pressure.

• Some piston rods have a 13- to 16-mm dia. through hole. If the wall thickness is reduced or the wall is broken when a hex. screw is fitted, oil leakage can occur. Fit the screw carefully.

• The working temperature range depends on the seal material. For details, refer to the selection materials at the beginning of this catalog.

• In the case that the lock nut is attached to the piston rod end thread part, increase the thread length (dimension A).

• Conex, material of the boots, is the registered trademark of Teijin Limited.

Product Lineup

Unit: mm

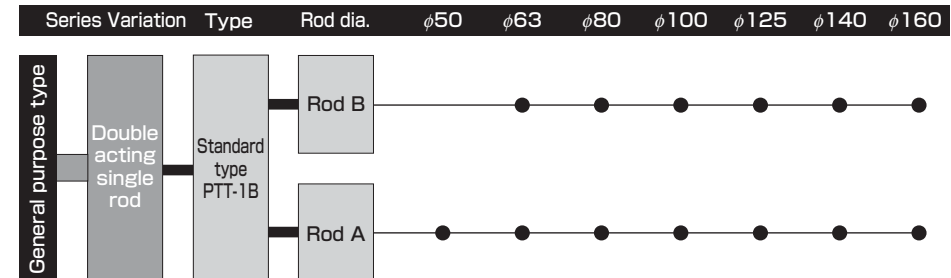

Detector Specifications

Power supply	24 V DC $\pm 2\text{V}$ 0.05A	
Accuracy	Linearity	$\pm 0.025\% \text{FS}$ or $\pm 75 \mu\text{mTYP}$
	Resolution	$\pm 0.01\% \text{FS}$ or less or $\pm 30 \mu\text{m}$ or less
	Repeatability	$\pm 0.01\% \text{FS}$ or less or $\pm 30 \mu\text{m}$ or less
Output	Temperature characteristics	40 ppmFS/ or less or 12 $\mu\text{m}/$ or less
	Standard	Current output of 4 to 20 mA, load resistance of 500 Ω or less
Output	semi-standard	Voltage output: Load current: 5 mA max. 0 to 10 V Load resistance: 2 k Ω min.
	Frequency characteristics	Scanning frequency 1 kHz
Working temperature range	-20°C to $+80^{\circ}\text{C}$	
Impact resistance	50G 2m1S	
Vibration resistance	6 G or 40 Hz 2mmPP	
Protective structure	IP67 (10kPa, 30min)	
Connection	Pin No.	Signal
	1	24 V DC
	2	0V
	3	Output
	4	COM
Shield to be connected to 0 V by user 0 V and COM are connected internally.		
Supplied connector	OMRON XS2C-D4S1	
Applicable cable (not supplied)	Outer diameter: 5 to 6 mm Wire size: 0.18 to 0.75 mm ²	

* Above shown are the specifications for the sensor only.

* A larger value of two values of each accuracy item is applicable.

• In the mounted state on the cylinder, the above accuracy cannot be assured due to deformation of cylinder elements caused by pressure and load. For the repeatability under the same conditions, a value close to the above accuracy can be obtained.

• The output is 4.0 to 4.5 mA or 0 to 0.3 V at the cylinder retracting end and 12 to 20 mA or 5 to 10 V at the cylinder advancing end. (At some cylinder strokes, part of the sensor effective length may not be used.) Set the controller conditions based on the actual output at the cylinder advancing and retracting ends.

Stroke Range

Unit: mm

Bore	Stroke
$\phi 50$ to $\phi 160$	to 1500

• The above strokes indicate the maximum available strokes for the standard type. Contact us for longer strokes.

• For the rod buckling, check with the buckling chart in the selection materials.

Cushion Stroke Length

Unit: mm

Bore	Cushion ring length L	Cushion ring parallel part length l
$\phi 50 \cdot \phi 63$	25	7
$\phi 80$ to $\phi 125$	30	8
$\phi 140$ to $\phi 160$	30	12

The cushion stroke lengths in case of cylinders used up to the stroke end. In the case that a cylinder is not used up to the stroke end, and it is stopped 5 mm or more before the stroke end, the cushioning effect will be weakened.

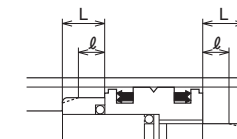

How to order

General Purpose Type

The item enclosed by broken line needs not to be entered, if unnecessary. Semi-standard specification

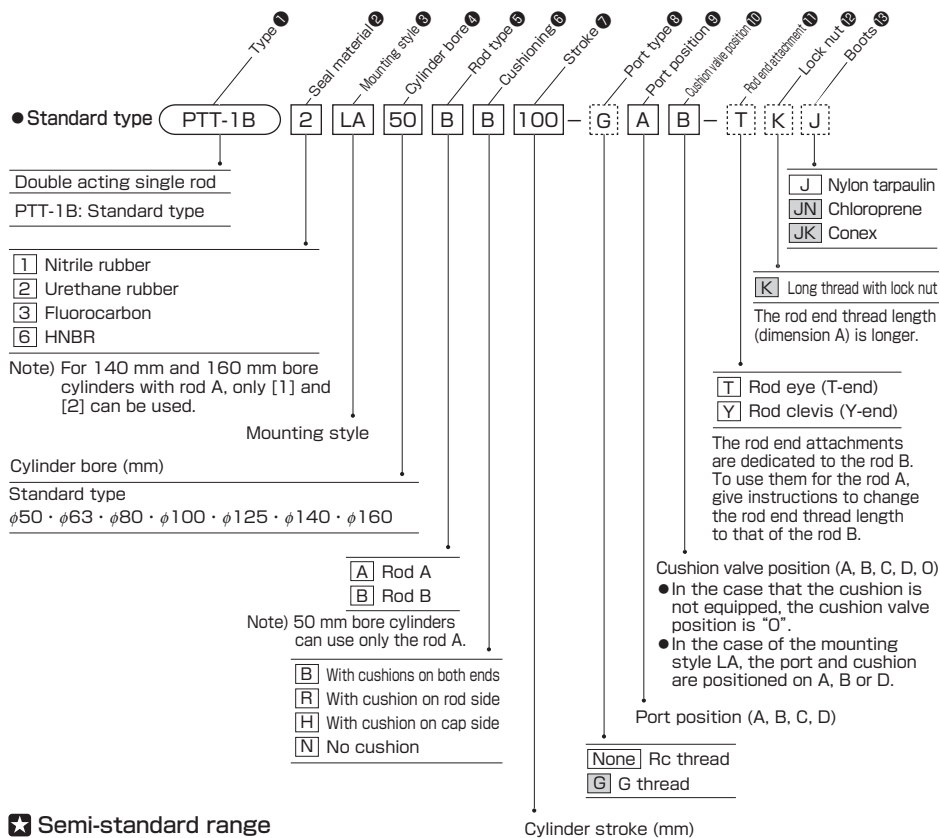

★ Semi-standard range

- With boots
- Change of piston rod end
- Change of TC accessory position
- Plated cylinder tube (hard chrome plating thickness: 0.02 mm)
- Specification of working fluid (water-glycol fluid)
- Specification of dimension BB (extension of tie rod)

Mounting style

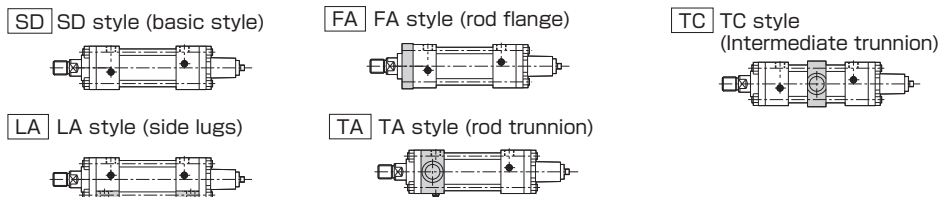

Weight Table

Unit: kg

Bore (mm)	Rod type	Basic weight (SD style)	Additional weight per mm of stroke	Mounting accessory additional weight				Rod end attachment weight			
				LA	FA	TA	TC	Rod eye (T-end)	Rod clevis (Y-end)	With lock nut	
								Nut only	Standard		
φ50	A	8.1	0.019	0.78	1.24	0.28	1.08	—	—	0.22	0.36
	B	—	—	—	—	—	—	1.67	2.30	0.11	0.18
φ63	A	12.7	0.029	1.12	1.66	0.54	1.80	—	—	0.48	0.81
	B	12.1	0.024	1.12	1.50	0.54	1.80	2.51	3.97	0.22	0.36
φ80	A	19.5	0.043	1.57	2.55	1.17	3.25	—	—	0.91	1.48
	B	18.5	0.036	1.57	2.09	1.17	3.25	3.77	6.54	0.48	0.81
φ100	A	29.9	0.065	2.44	5.11	2.87	7.02	—	—	1.84	3.10
	B	28.1	0.054	2.44	4.23	2.81	7.02	7.47	12.62	0.91	1.48
φ125	A	53.1	0.104	4.46	7.21	5.01	14.15	—	—	3.23	5.80
	B	50.8	0.084	4.46	6.19	5.01	14.15	12.41	22.96	1.84	3.10
φ140	A	75.4	0.131	8.18	8.71	7.43	20.61	—	—	5.16	9.60
	B	72.0	0.109	8.18	5.76	7.43	20.61	19.17	33.75	2.50	4.42
φ160	A	102.6	0.166	13.21	13.10	12.02	26.14	—	—	6.22	11.14
	B	98.5	0.142	13.21	10.16	12.02	26.14	26.97	46.72	3.23	5.80

- Notes) ● See the "With lock nut - Standard" column when the nut symbol is K. The values include the weight for the increase in screw length.
 ● The rod eye and rod clevis are dedicated to the rod B.
 When the rod A is used, change the rod end thread diameter to that of the rod B.

Sectional Drawing

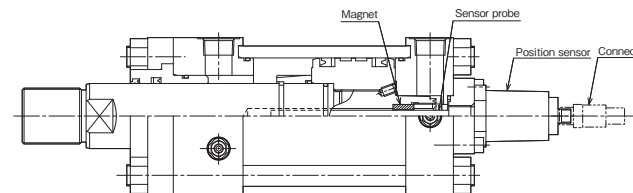

Note) The structure differs slightly depending on the cylinder bore and the position sensor model.

Application Example

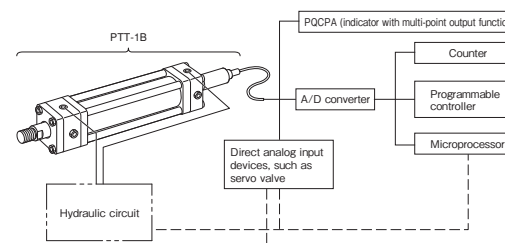

- The cylinder position and operation can be checked on the counter, and position adjustment and inching can be easily performed by manual operation.
- When combined with a personal computer or a microprocessor, the cylinder can be decelerated and stopped at any position.

Principle of Operation of Position Sensor

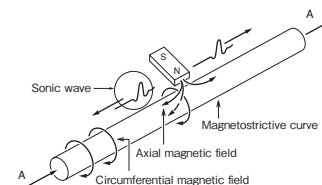

The figure shows the basic principle. When a current pulse shown by arrow A is given to the magnetostrictive curve, a circumferential magnetic field is generated on the magnetostrictive curve. When a magnet is positioned as shown in the figure, an axial magnetic field is given only to the position, and a diagonal magnetic field as shown by the dotted line is generated, thereby causing torsion in this part of the magnetostrictive curve. Since this torsion is a kind of vibration, it propagates at the sonic speed on the magnetostrictive curve which is a metallic tube. PTT-1B Series uses absolute type position sensors which measure the propagation time at the supersonic speed to find the magnet position.

Discontinued

PQCPA Series dedicated to analog/pulse output from position sensing cylinders

- Environmentally-friendly lead-free indicator.
- Analog input and pulse input types are available.
- Provided with multi-point output function (5 points) as a standard function to enable to individually set the upper and lower limits.^{Note 1)}
- A 16-bit AD converter is provided to realize high resolution. (Analog input type)
- Provided with a counter with a response frequency of 200 kHz (Pulse input type)
- Provided with a pulse position correcting function.^{Note 2)}



Note 1) Setting the bank switching enables to use the multi-output function of up to 15 points.

Note 2) Position correction can be made by mounting a cylinder sensor. Positional error caused by slippage of the encoder is eliminated.

Standard Specifications

Type	Analog	Pulse
Model number	PQCPA-CU-A	PQCPA-CU-P
Applicable input signals	Analog voltage/analog current	Phase AB
Display range	±999999	
Resolution	Stroke×1/10000	—
Response frequency	1 kHz	200 kHz
Linearity	±0.02%FS	—
Signals	Voltage input 0 to 10 V Voltage input 1 to 5 V Current input 4 to 20 mA	Open collector input Differential input (line driver input) 12 V voltage input 24 V voltage input
Monitor output	Voltage output Note)	Line driver output
Sampling speed	1000 times/sec	
Display speed	10 times/sec	
Display method	Display by fluorescent display tube	
Control input	No-voltage input (reed sensor/solid state sensor)	
Control output	Open collector Max. rating: 50 V DC, 50 mA (Provided with multi-point output function (5 points) to enable to individually set the upper and lower limits and pulse position correcting function)	
Power supply voltage	24 V DC ±10%	
Ambient temperature	0 to 50°C (No freezing)	
Ambient humidity	35 to 85%RH (No condensing)	

Note) The monitor output at current input (4 to 20 mA) is voltage output of 1 to 5 V.

Function Table

Type	Analog input	Pulse input
Model number	PQCPA-CU-A-A	PQCPA-CU-P-12
	PQCPA-CU-A-V	PQCPA-CU-P-24
Functions	—	PQCPA-CU-P-00
	Display of position	Display of position
	Bank switching	Bank switching
	Multi-point output	Multi-point output
	Positional data hold	Positional data hold
	—	0 setting signal
	—	Correcting function

List of Applicable Actuators

Series	Detection method	Signal type
PTN-1B	Absolute method	Analog type (4 to 20 mA, 0 to 10 V)
PTH-1B		
PTT-1B		
PSR-1A		
35P-3	Linear pulse encoder	Encoder type
70P-8		
140P-8		

Note) For the details of each cylinder, refer to the section of each series.

● How to order **Discontinued**

Position Indicator

● Analog input

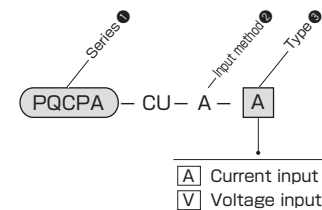

● Pulse input

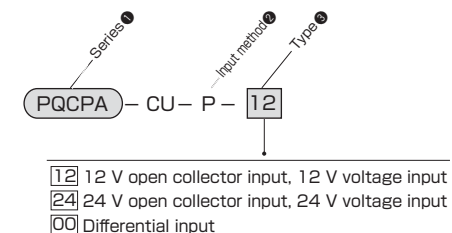

Note) Cylinders do not come with indicators of differential input type [00]. (Specification to use the indicator in stand-alone state)

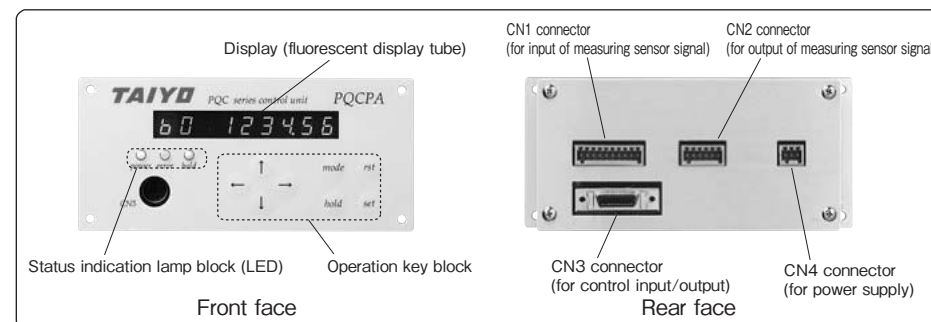

Dimensional Drawings

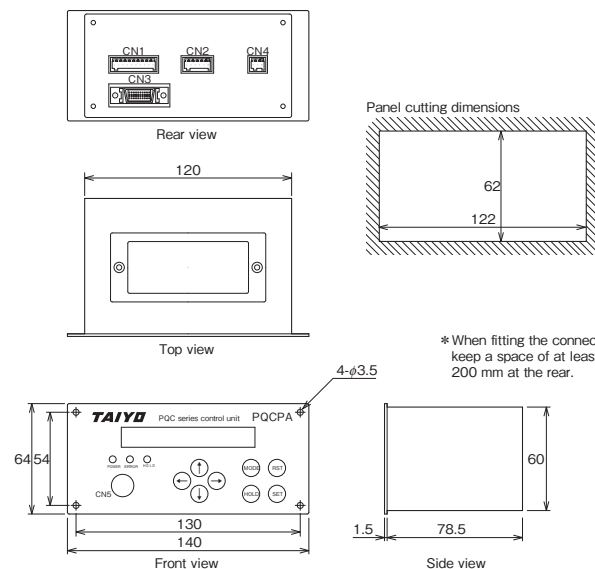

Supplied Connector

- CN1 connector (for input of measuring sensor signal)
- CN2 connector (for output of measuring sensor signal)
- CN3 connector (for control input/output)
- CN4 connector (for power supply)

Discontinued

How to order cable between sensor and indicator

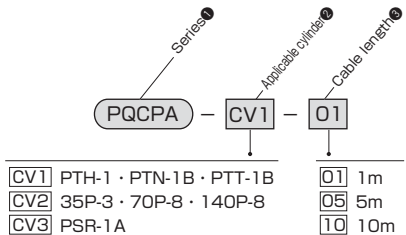

- * When ordering a cable, confirm the series name of the actuator on the sensor side. Some models cannot be connected.
- * After wiring, connect the indicator side connector to the CN1 connector on the indicator.

PQCPA-CV1- Cable length

Applicable actuators: PTH-1B/PTN-1B/PTT-1B

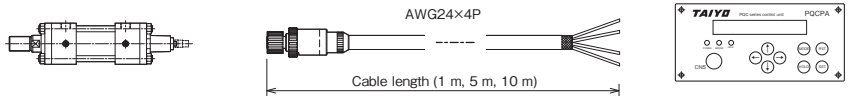

PQCPA-CV2- Cable length

Applicable actuators: 35P-3/70P-8/140P-8

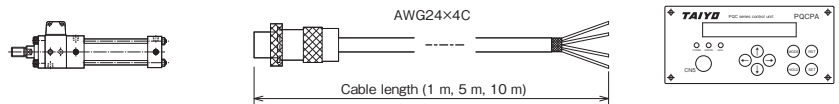

PQCPA-CV3- Cable length

Applicable actuators: PSR-1A

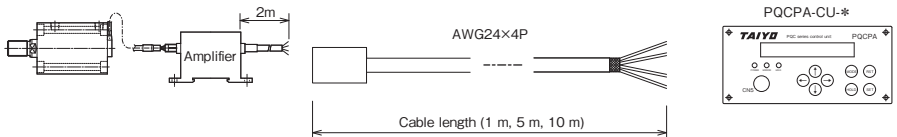

Note) PSR-1A comes with a 2m cable as a standard accessory. If another cable is required, select this cable. (In this case, disconnect the standard cable (2 m) of PSR-1A, and connect the selected cable directly to the amplifier.)

How to order I/O cable

PQCPA - IO

*The I/O cable is 5 m long.

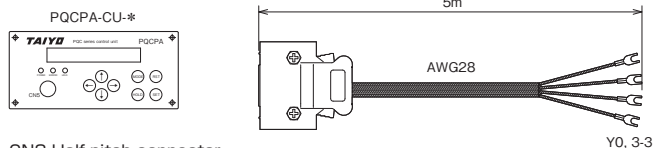

CN3 Half-pitch connector
Note) Only the CN3 half-pitch connector is supplied as a standard accessory. If you need the connector with a cable, place an order for the connector.

Discontinued

External input/output

CN1

Pin No.	Description	Signals
1	Voltage/current input	Analog input
2	NC	-
3	Voltage/current GND	Analog input
4	Phase A	Pulse input
5	Phase -A	Pulse input
6	Phase B	Pulse input
7	Phase -B	Pulse input
8	+24V	Power supply output
9	+12V	Power supply output
10	GND	Power supply output/Phase AB GND

CN2

Pin No.	Description	Signals
1	Pout	Analog output
2	Vss	Analog output
3	A pulse	Pulse output
4	A pulse GND	Pulse output
5	B pulse	Pulse output
6	B pulse GND	Pulse output

CN4

Pin No.	Description	Signals
1	P24	Power supply
2	N24	Power supply
3	PE	Power supply

CN3

Pin No.	Description	Signals
1	0 setting signal	Input
2	Positional data hold	Input
3	Correcting function	Input
4	Bank switching 0	Input
5	Bank switching 1	Input
6	Bank switching 2	Input
7	Reserved input	Input
8	Reserved input	Input
9	Input common	Input
10	Input common	Input
11	Multi-point output signal 0	Output
12	Multi-point output signal 1	Output
13	Multi-point output signal 2	Output
14	Multi-point output signal 3	Output
15	Multi-point output signal 4	Output
16	Reserved output	Output
17	Reserved output	Output
18	Reserved output	Output
19	Output common	Output
20	Output common	Output

*For details, see the instruction manual.

Example of product configuration

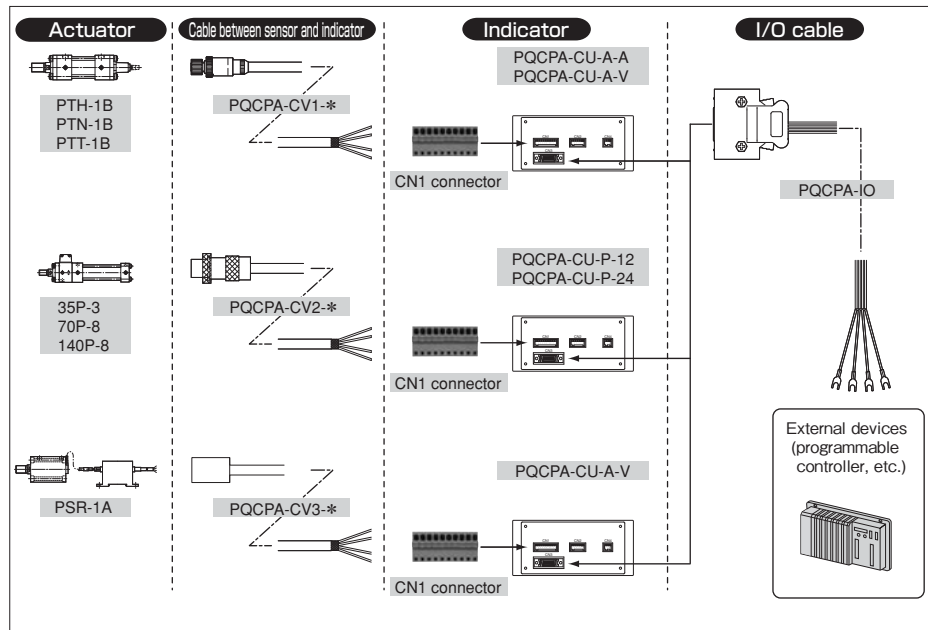

SD

PTT-1B [2] SD Bore [B] Stroke

Port G thread type

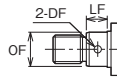

Rod dia.	OF	DF	LF
φ90	φ89.5	φ12	28
φ100	φ99.5	φ12	28
φ110	φ109.5	φ15	30

Drill hole for rod dia. of φ90 or more
 Note) The diameter of the rod B of 160 mm bore cylinder is 90 mm, but it is the width across flats.

● Bore φ50 and φ63

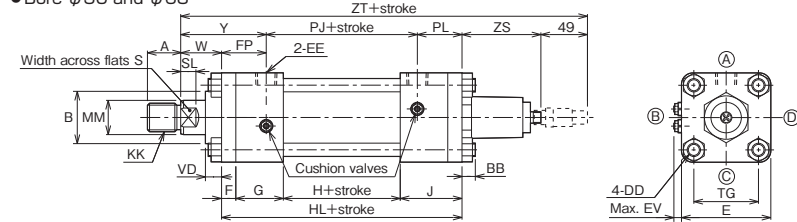

● Bore φ80 to φ160

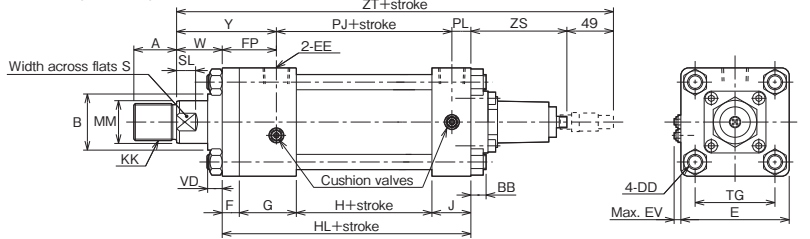

- The cushion valve position varies depending on the bore.
- For the thread length (dimension A) when the lock nut is used, refer to the "Thread length of rod end with lock nut".
- If you want to change the rod protrusion length, specify dimension W.
- The shape of the position sensor mounting area varies depending on the bore.

With Boots

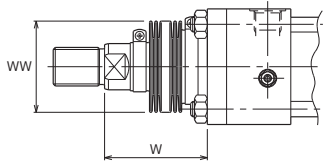

	Standard	Semi-standard	
Material	Nylon tarpaulin	Chloroprene	Conex
Heat proof	80°C	130°C	200°C

- Notes) ● Remember that the heat proof field in the table above shows the allowable temperatures for the boots, not for the cylinder.
 ● The boots have been mounted at our factory prior to delivery.
 ● Conex is the registered trademark of Teijin Limited.

Rod A

Nylon tarpaulin	φ50 to φ80	1/4 stroke+X
Chloroprene	φ100 to φ160	1/5 stroke+X

Conex

φ50 to φ80	1/3 stroke+X
φ100	1/3.5 stroke+X
φ125 to φ160	1/4 stroke+X

Dimension W

Rod B

Nylon tarpaulin	φ63 to φ100	1/4 stroke+X
Chloroprene	φ125 to φ160	1/5 stroke+X

Conex

φ63 to φ100	1/3 stroke+X
φ125·φ140	1/3.5 stroke+X
φ160	1/4 stroke+X

- If the calculated value has a fractional part, round it up.

Dimensional Table

Symbol	Rod B									Rod A								
	A	B	KK	MM	S	SL	VD	W	Y	A	B	KK	MM	S	SL	VD	W	Y
φ50	-	-	-	-	-	-	-	-	-	35	φ55	M30×1.5	φ36	30	16	15	36	78
φ63	35	φ55	M30×1.5	φ36	30	16	15	43	90	45	φ65	M39×1.5	φ45	41	20	19	43	90
φ80	45	φ65	M39×1.5	φ45	41	20	12	48	105	55	φ80	M48×1.5	φ56	50	23	19	48	105
φ100	55	φ80	M48×1.5	φ56	50	23	15	53	114	75	φ95	M64×2	φ70	65	27	19	53	114
φ125	75	φ95	M64×2	φ70	65	27	19	60	133	90	φ120	M80×2	φ90	-	-	28	60	133
φ140	80	φ105	M72×2	φ80	75	31	15	60	141	105	φ130	M95×2	φ100	-	-	24	60	141
φ160	90	φ120	M80×2	φ90	85	33	15	60	146	110	φ140	M100×2	φ110	-	-	24	60	146

Symbol	AE	BB	DD	DE	E	EE	EV	F	FF	FP	G	H	HL	J	PJ	PL	TG
φ50	14	13	M12×1.25	φ30	□80	Rc1/2	10	13	G1/2	42	47	66	186	60	102	42	□56
φ63	14	14	M14×1.5	φ30	□94	Rc1/2	10	15	G1/2	47	50	73	203	65	109	47	□68
φ80	16	16	M16×1.5	φ36.9	□114	Rc3/4	10	18	G3/4	57	60	83	202	41	125	20	□84
φ100	16	18	M18×1.5	φ36.9	□135	Rc3/4	11	22	G3/4	61	60	90	213	41	132	20	□102
φ125	18	21	M22×1.5	φ46.1	□165	Rc1	11	24	G1	73	75	98	248	51	150	25	□125
φ140	18	25	M27×2	φ46.1	□192	Rc1	13	32	G1	81	75	108	266	51	160	25	□144
φ160	18	27	M30×2	φ46.1	□218	Rc1	13	37	G1	86	75	127	290	51	179	25	□164

Symbol	ZS	ZT
φ50	96	367
φ63	83	378
φ80	101	400
φ100	101	416
φ125	103	460
φ140	103	478
φ160	103	502

With Boots

Symbol	Bore	φ50	φ63	φ80	φ100	φ125	φ140	φ160
		WW	Rod B	-	φ71	φ80	φ100	φ125
		Rod A	φ71	φ80	φ100	φ140	φ160	φ180
X	Rod B	-	55	55	55	65	65	65
	Rod A	55	55	55	65	65	65	65

LA

PTT-1B [2] LA [Bore] [B] B Stroke

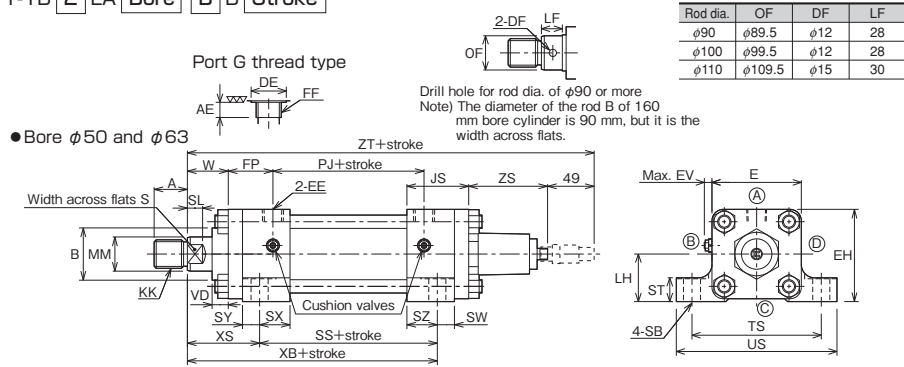

Rod dia.	OF	DF	LF
φ90	φ89.5	φ12	28
φ100	φ99.5	φ12	28
φ110	φ109.5	φ15	30

Drill hole for rod dia. of φ90 or more
 Note) The diameter of the rod B of φ160 mm bore cylinder is 90 mm, but it is the width across flats.

● Bore φ50 and φ63

● Bore φ80 to φ160

- The cushion valve position varies depending on the bore.
- For the thread length (dimension A) when the lock nut is used, refer to the "Thread length of rod end with lock nut".
- If you want to change the rod protrusion length, specify dimension W.
- The shape of the position sensor mounting area varies depending on the bore.

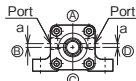

Bore	φ50	φ63	φ80	φ100	φ125	φ140	φ160
a	6	6	10	10	10	0	0

With Boots

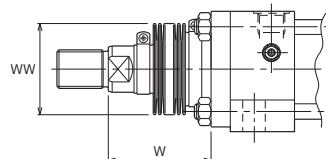

	Standard	Semi-standard	
Material	Nylon tarpaulin	Chloroprene	Conex
Heat proof	80°C	130°C	200°C

Notes ● Remember that the heat proof field in the table above shows the allowable temperatures for the boots, not for the cylinder.
 ● The boots have been mounted at our factory prior to delivery.
 ● Conex is the registered trademark of Teijin Limited.

Rod A

Nylon tarpaulin
 Chloroprene

(φ50 to φ80 1/4 stroke+X)	(φ100 to φ160 1/5 stroke+X)
---------------------------	-----------------------------

Conex

(φ50 to φ80 1/3 stroke+X)	(φ100 1/3.5 stroke+X)	(φ125 to φ160 1/4 stroke+X)
---------------------------	-----------------------	-----------------------------

Dimension W

Rod B
 Nylon tarpaulin
 Chloroprene

(φ63 to φ100 1/4 stroke+X)	(φ125 to φ160 1/5 stroke+X)
----------------------------	-----------------------------

Conex

(φ63 to φ100 1/3 stroke+X)	(φ125·φ140 1/3.5 stroke+X)	(φ160 1/4 stroke+X)
----------------------------	----------------------------	---------------------

● If the calculated value has a fractional part, round it up.

Dimensional Table

Symbol	Rod B							Rod A								
	A	B	KK	MM	S	SL	VD	W	A	B	KK	MM	S	SL	VD	W
φ50	-	-	-	-	-	-	-	-	35	φ55	M30×1.5	φ36	30	16	15	36
φ63	35	φ55	M30×1.5	φ36	30	16	15	43	45	φ65	M39×1.5	φ45	41	20	19	43
φ80	45	φ65	M39×1.5	φ45	41	20	12	48	55	φ80	M48×1.5	φ56	50	23	19	48
φ100	55	φ80	M48×1.5	φ56	50	23	15	53	75	φ95	M64×2	φ70	65	27	19	53
φ125	75	φ95	M64×2	φ70	65	27	19	60	90	φ120	M80×2	φ90	-	-	28	60
φ140	80	φ105	M72×2	φ80	75	31	15	60	105	φ130	M95×2	φ100	-	-	24	60
φ160	90	φ120	M80×2	φ90	85	33	15	60	110	φ140	M100×2	φ110	-	-	24	60

Symbol	AE	DE	E	EE	EH	EV	FF	FP	JS	LH	PJ	SB	SS	ST	SW	SX	SY	SZ
φ50	14	φ30	□80	Rc1/2	85	10	G1/2	42	60	45±0.15	102	φ14	124	20	18	29	18	29
φ63	14	φ30	□94	Rc1/2	97	10	G1/2	47	65	50±0.15	109	φ18	137	25	18	32	18	32
φ80	16	φ36.9	□114	Rc3/4	117	10	G3/4	57	41	60±0.25	125	φ18	143	30	20	39	21	21
φ100	16	φ36.9	□135	Rc3/4	137.5	11	G3/4	61	41	70±0.25	132	φ22	150	35	18	37	23	23
φ125	18	φ46.1	□165	Rc1	167.5	11	G1	73	51	85±0.25	150	φ26	173	45	23	47	28	28
φ140	18	φ46.1	□192	Rc1	196	13	G1	81	56	100±0.25	160	φ30	183	45	28	47	28	28
φ160	18	φ46.1	□218	Rc1	224	13	G1	86	60	115±0.25	179	φ33	202	55	30	45	30	30

Symbol	TS	US	XB	XS	ZS	ZT
φ50	115	145	191	67	96	367
φ63	136	169	213	76	83	378
φ80	155	190	230	87	101	400
φ100	190	230	248	98	101	416
φ125	224	272	285	112	103	460
φ140	262	320	303	120	103	483
φ160	294	356	329	127	103	511

With Boots

Symbol	Bore	φ50	φ63	φ80	φ100	φ125	φ140	φ160
WW	Rod B	-	φ71	φ80	φ100	φ125	φ125	φ140
	Rod A	φ71	φ80	φ100	φ125	φ140	φ160	φ180
X	Rod B	-	55	55	55	65	65	65
	Rod A	55	55	55	65	65	65	65

FA

PTT-1B [2] FA Bore [B] Stroke

Port G thread type

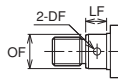

Rod dia.	OF	DF	LF
φ90	φ89.5	φ12	28
φ100	φ99.5	φ12	28
φ110	φ109.5	φ15	30

Drill hole for rod dia. of φ90 or more
 Note) The diameter of the rod B of 160 mm bore cylinder is 90 mm, but it is the width across flats.

• Bore φ50 and φ63

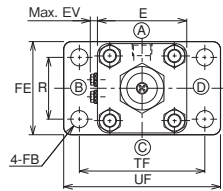
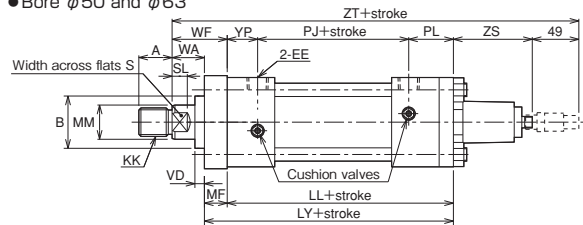

• Bore φ80 to φ160

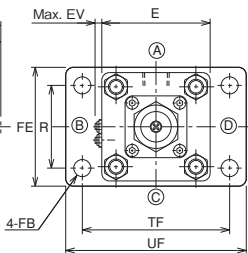
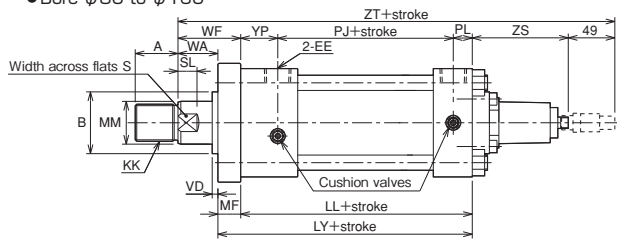

- The cushion valve position varies depending on the bore.
- For the thread length (dimension A) when the lock nut is used, refer to the "Thread length of rod end with lock nut".
- If you want to change the rod protrusion length, specify dimension WA.
- The shape of the position sensor mounting area varies depending on the bore.

With Boots

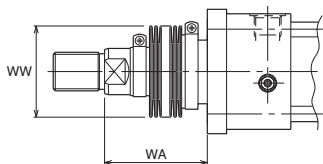

	Standard	Semi-standard	
Material	Nylon tarpaulin	Chloroprene	Conex
Heat proof	80°C	130°C	200°C

- Notes
- Remember that the heat proof field in the table above shows the allowable temperatures for the boots, not for the cylinder.
 - The boots have been mounted at our factory prior to delivery.
 - Conex is the registered trademark of Teijin Limited.

Dimension W

Rod B

Nylon tarpaulin
 Chloroprene

φ63 to φ100	1/4 stroke+X
φ125 to φ160	1/5 stroke+X

Conex

φ63 to φ100	1/3 stroke+X
φ125·φ140	1/3.5 stroke+X
φ160	1/4 stroke+X

Rod A

Nylon tarpaulin
 Chloroprene

φ50 to φ80	1/4 stroke+X
φ100 to φ160	1/5 stroke+X

Conex

φ50 to φ80	1/3 stroke+X
φ100	1/3.5 stroke+X
φ125 to φ160	1/4 stroke+X

- If the calculated value has a fractional part, round it up.
- The gland bush for the mounting style FA differs from that for a cylinder with boots.

Dimensional Table

Symbol Bore	Rod B								Rod A									
	A	B	KK	MM	S	SL	VD	WA	WF	A	B	KK	MM	S	SL	VD	WA	WF
φ50	-	-	-	-	-	-	-	-	-	35	φ55	M30×1.5	φ36	30	16	8	29	49
φ63	35	φ55	M30×1.5	φ36	30	16	6	34	58	45	φ65	M39×1.5	φ45	41	20	10	34	58
φ80	45	φ65	M39×1.5	φ45	41	20	6	42	66	55	φ80	M48×1.5	φ56	50	23	13	42	66
φ100	55	φ80	M48×1.5	φ56	50	23	6	44	75	75	φ95	M64×2	φ70	65	27	10	44	75
φ125	75	φ95	M64×2	φ70	65	27	6	47	84	90	φ120	M80×2	φ90	-	-	15	47	84
φ140	80	φ105	M72×2	φ80	75	31	6	51	92	105	φ130	M95×2	φ100	-	-	15	51	92
φ160	90	φ120	M80×2	φ90	85	33	6	51	97	110	φ140	M100×2	φ110	-	-	15	51	97

Symbol Bore	AE	DE	E	EE	EV	FB	Rod B		Rod A		FF	LL	Rod B		Rod A		PJ	PL
							FE	FE	LY	LY			MF	MF				
φ50	14	φ30	□80	Rc1/2	10	φ14	-	92	G1/2	173	-	193	-	20	102	42		
φ63	14	φ30	□94	Rc1/2	10	φ18	98	105	G1/2	188	212	212	24	24	109	47		
φ80	16	φ36.9	□114	Rc3/4	10	φ18	125	140	G3/4	184	208	208	24	24	125	20		
φ100	16	φ36.9	□135	Rc3/4	11	φ22	150	165	G3/4	191	222	222	31	31	132	20		
φ125	18	φ46.1	□165	Rc1	11	φ26	175	195	G1	224	261	261	37	37	150	25		
φ140	18	φ46.1	□192	Rc1	13	φ30	195	215	G1	234	275	275	41	41	160	25		
φ160	18	φ46.1	□218	Rc1	13	φ33	225	245	G1	253	299	299	46	46	179	25		

Symbol Bore	R	TF	UF	YP	ZS	ZT
φ50	58	115	145	29	96	367
φ63	65	132	165	32	83	378
φ80	87	155	190	39	101	400
φ100	109	190	230	39	101	416
φ125	130	224	272	49	103	460
φ140	145	250	300	49	103	478
φ160	170	285	345	49	103	502

With Boots

Symbol	Bore	φ50	φ63	φ80	φ100	φ125	φ140	φ160
		WW	Rod B	-	φ71	φ80	φ100	φ125
	Rod A	φ71	φ80	φ100	φ125	φ140	φ160	φ180
X	Rod B	-	55	55	55	65	65	65
	Rod A	55	55	55	65	65	65	65

TA

PTT-1B 2 TA Bore B B Stroke

Port G thread type

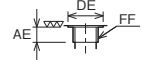

Drill hole for rod dia. of $\phi 90$ or more
 Note) The diameter of the rod B of 160 mm bore cylinder is 90 mm, but it is the width across flats.

Rod dia.	OF	DF	LF
$\phi 90$	$\phi 89.5$	$\phi 12$	28
$\phi 100$	$\phi 99.5$	$\phi 12$	28
$\phi 110$	$\phi 109.5$	$\phi 15$	30

● Bore $\phi 50$ and $\phi 63$

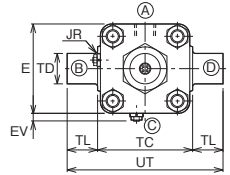
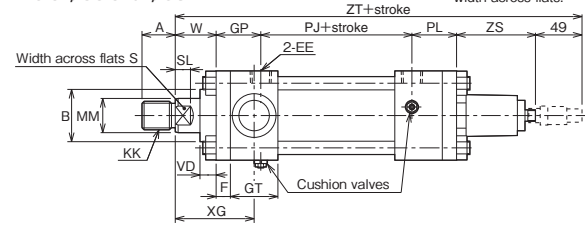

● Bore $\phi 80$ to $\phi 160$

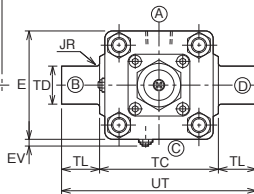
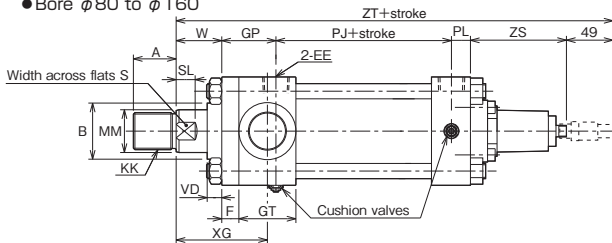

- The cushion valve position varies depending on the bore.
- For the thread length (dimension A) when the lock nut is used, refer to the "Thread length of rod end with lock nut".
- If you want to change the rod protrusion length, specify dimension W.
- The shape of the position sensor mounting area varies depending on the bore.
- The port and cushion positions on the rod side are only $\text{\textcircled{A}}$ or $\text{\textcircled{C}}$ due to structural reasons.

With Boots

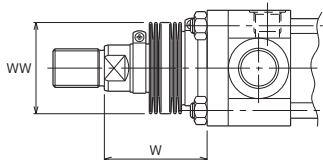

	Standard	Semi-standard	
Material	Nylon tarpaulin	Chloroprene	Conex
Heat proof	80°C	130°C	200°C

Notes) ● Remember that the heat proof field in the table above shows the allowable temperatures for the boots, not for the cylinder.

- The boots have been mounted at our factory prior to delivery.
- Conex is the registered trademark of Teijin Limited.

Rod A

Nylon tarpaulin	$(\phi 50 \text{ to } \phi 80 \quad 1/4 \text{ stroke}+X)$
Chloroprene	$(\phi 100 \text{ to } \phi 160 \quad 1/5 \text{ stroke}+X)$

Rod B

Nylon tarpaulin	$(\phi 63 \text{ to } \phi 100 \quad 1/4 \text{ stroke}+X)$
Chloroprene	$(\phi 125 \text{ to } \phi 160 \quad 1/5 \text{ stroke}+X)$

Dimension W

Rod B

Nylon tarpaulin	$(\phi 63 \text{ to } \phi 100 \quad 1/4 \text{ stroke}+X)$
Chloroprene	$(\phi 125 \text{ to } \phi 160 \quad 1/5 \text{ stroke}+X)$

Rod A

Nylon tarpaulin	$(\phi 63 \text{ to } \phi 100 \quad 1/3 \text{ stroke}+X)$
Chloroprene	$(\phi 125 \text{ to } \phi 140 \quad 1/3.5 \text{ stroke}+X)$
Conex	$(\phi 160 \quad 1/4 \text{ stroke}+X)$

- If the calculated value has a fractional part, round it up.

Dimensional Table

Symbol	Rod B							Rod A								
	A	B	KK	MM	S	SL	VD	W	A	B	KK	MM	S	SL	VD	W
$\phi 50$	-	-	-	-	-	-	-	-	35	$\phi 55$	M30×1.5	$\phi 36$	30	16	15	36
$\phi 63$	35	$\phi 55$	M30×1.5	$\phi 36$	30	16	15	43	45	$\phi 65$	M39×1.5	$\phi 45$	41	20	19	43
$\phi 80$	45	$\phi 65$	M39×1.5	$\phi 45$	41	20	12	48	55	$\phi 80$	M48×1.5	$\phi 56$	50	23	19	48
$\phi 100$	55	$\phi 80$	M48×1.5	$\phi 56$	50	23	15	53	75	$\phi 95$	M64×2	$\phi 70$	65	27	19	53
$\phi 125$	75	$\phi 95$	M64×2	$\phi 70$	65	27	19	60	90	$\phi 120$	M80×2	$\phi 90$	-	-	28	60
$\phi 140$	80	$\phi 105$	M72×2	$\phi 80$	75	31	15	60	105	$\phi 130$	M95×2	$\phi 100$	-	-	24	60
$\phi 160$	90	$\phi 120$	M80×2	$\phi 90$	85	33	15	60	110	$\phi 140$	M100×2	$\phi 110$	-	-	24	60

Symbol	AE	DE	E	EE	EV	F	FF	GP	GT	JR	PJ	PL	TC	TD	TL	UT
$\phi 50$	14	$\phi 30$	$\square 80$	Rc1/2	10	13	G1/2	42	47	R2.5	102	42	$85^{0}_{-0.35}$	$\phi 25e9$	25	135
$\phi 63$	14	$\phi 30$	$\square 94$	Rc1/2	10	15	G1/2	47	50	R2.5	109	47	$100^{0}_{-0.35}$	$\phi 32e9$	32	164
$\phi 80$	16	$\phi 36.9$	$\square 114$	Rc3/4	10	18	G3/4	57	60	R3	125	20	$125^{0}_{-0.4}$	$\phi 40e9$	40	205
$\phi 100$	16	$\phi 36.9$	$\square 135$	Rc3/4	11	22	G3/4	66	65	R3	132	20	$155^{0}_{-0.4}$	$\phi 50e9$	50	255
$\phi 125$	18	$\phi 46.1$	$\square 165$	Rc1	11	24	G1	73	75	R4	150	25	$195^{0}_{-0.46}$	$\phi 63e9$	63	321
$\phi 140$	18	$\phi 46.1$	$\square 192$	Rc1	13	32	G1	86	80	R4	160	25	$220^{0}_{-0.46}$	$\phi 70e9$	70	360
$\phi 160$	18	$\phi 46.1$	$\square 218$	Rc1	13	37	G1	111	100	R4	179	25	$240^{0}_{-0.46}$	$\phi 80e9$	80	400

Symbol	XG	ZS	ZT
$\phi 50$	72	96	367
$\phi 63$	83	83	378
$\phi 80$	96	101	400
$\phi 100$	107	101	421
$\phi 125$	122	103	460
$\phi 140$	132	103	483
$\phi 160$	147	103	527

With Boots

Symbol	Bore	$\phi 50$	$\phi 63$	$\phi 80$	$\phi 100$	$\phi 125$	$\phi 140$	$\phi 160$
		WW	Rod B	-	$\phi 71$	$\phi 80$	$\phi 100$	$\phi 125$
	Rod A	$\phi 71$	$\phi 80$	$\phi 100$	$\phi 125$	$\phi 140$	$\phi 160$	$\phi 180$
X	Rod B	-	55	55	55	65	65	65
	Rod A	55	55	55	65	65	65	65

TC

PTT-1B 2 TC Bore B Stroke

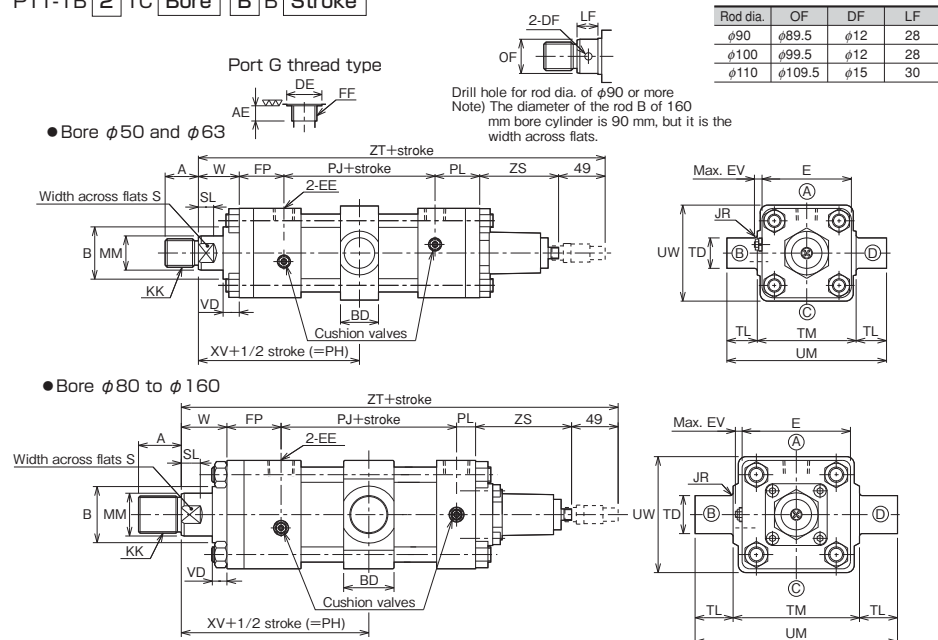

● Bore φ50 and φ63

● Bore φ80 to φ160

- The cushion valve position varies depending on the bore.
- For the thread length (dimension A) when the lock nut is used, refer to the "Thread length of rod end with lock nut".
- If you want to change the rod protrusion length, specify dimension W.
- The shape of the position sensor mounting area varies depending on the bore.
- If dimension PH is small, pay attention to the cushion valve position.

With Boots

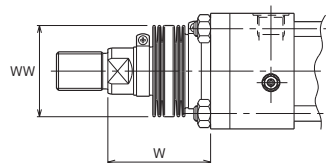

	Standard	Semi-standard	
Material	Nylon tarpaulin	Chloroprene	Conex
Heat proof	80°C	130°C	200°C

- (Notes) ● Remember that the heat proof field in the table above shows the allowable temperatures for the boots, not for the cylinder.
 ● The boots have been mounted at our factory prior to delivery.
 ● Conex is the registered trademark of Teijin Limited.

Rod A

Nylon tarpaulin
 Chloroprene $(\phi 50 \text{ to } \phi 80 \quad 1/4 \text{ stroke}+X)$
 $(\phi 100 \text{ to } \phi 160 \quad 1/5 \text{ stroke}+X)$

Conex

$(\phi 50 \text{ to } \phi 80 \quad 1/3 \text{ stroke}+X)$
 $(\phi 100 \quad 1/3.5 \text{ stroke}+X)$
 $(\phi 125 \text{ to } \phi 160 \quad 1/4 \text{ stroke}+X)$

Dimension W

Rod B

Nylon tarpaulin
 Chloroprene $(\phi 63 \text{ to } \phi 100 \quad 1/4 \text{ stroke}+X)$
 $(\phi 125 \text{ to } \phi 160 \quad 1/5 \text{ stroke}+X)$

Conex

$(\phi 63 \text{ to } \phi 100 \quad 1/3 \text{ stroke}+X)$
 $(\phi 125 \cdot \phi 140 \quad 1/3.5 \text{ stroke}+X)$
 $(\phi 160 \quad 1/4 \text{ stroke}+X)$

- If the calculated value has a fractional part, round it up.

Dimensional Table

Symbol	Rod B							Rod A								
	A	B	KK	MM	S	SL	VD	W	A	B	KK	MM	S	SL	VD	W
φ50	-	-	-	-	-	-	-	-	35	φ55	M30×1.5	φ36	30	16	15	36
φ63	35	φ55	M30×1.5	φ36	30	16	15	43	45	φ65	M39×1.5	φ45	41	20	19	43
φ80	45	φ65	M39×1.5	φ45	41	20	12	48	55	φ80	M48×1.5	φ56	50	23	19	48
φ100	55	φ80	M48×1.5	φ56	50	23	15	53	75	φ95	M64×2	φ70	65	27	19	53
φ125	75	φ95	M64×2	φ70	65	27	19	60	90	φ120	M80×2	φ90	-	-	28	60
φ140	80	φ105	M72×2	φ80	75	31	15	60	105	φ130	M95×2	φ100	-	-	24	60
φ160	90	φ120	M80×2	φ90	85	33	15	60	110	φ140	M100×2	φ110	-	-	24	60

Symbol	AE	BD	DE	E	EE	EV	FF	FP	JR	Min. dimension PH	PJ	PL	TD	TL	TM
φ50	14	33	φ30	□80	Rc1/2	10	G1/2	42	R2.5	112.5	102	42	φ25e9	25	85 ⁰ _{-0.35}
φ63	14	43	φ30	□94	Rc1/2	10	G1/2	47	R2.5	129.5	109	47	φ32e9	32	100 ⁰ _{-0.35}
φ80	16	53	φ36.9	□114	Rc3/4	10	G3/4	57	R3	152.5	125	20	φ40e9	40	125 ⁰ _{-0.4}
φ100	16	63	φ36.9	□135	Rc3/4	11	G3/4	61	R3	166.5	132	20	φ50e9	50	155 ⁰ _{-0.4}
φ125	18	78	φ46.1	□165	Rc1	11	G1	73	R4	198	150	25	φ63e9	63	195 ⁰ _{-0.46}
φ140	18	88	φ46.1	□192	Rc1	13	G1	81	R4	211	160	25	φ70e9	70	220 ⁰ _{-0.46}
φ160	18	98	φ46.1	□218	Rc1	13	G1	86	R4	221	179	25	φ80e9	80	240 ⁰ _{-0.46}

Symbol	UM	UW	XV	ZS	ZT
φ50	135	80	129	96	367
φ63	164	94	144.5	83	378
φ80	205	114	167.5	101	400
φ100	255	146	180	101	416
φ125	321	185	208	103	460
φ140	360	210	221	103	478
φ160	400	230	235.5	103	502

With Boots

Symbol	Bore							
	φ50	φ63	φ80	φ100	φ125	φ140	φ160	
WW	Rod B	-	φ71	φ80	φ100	φ125	φ125	φ140
	Rod A	φ71	φ80	φ100	φ125	φ140	φ160	φ180
X	Rod B	-	55	55	55	65	65	65
	Rod A	55	55	55	65	65	65	65

Rod End Attachment

● Rod eye (T-end)

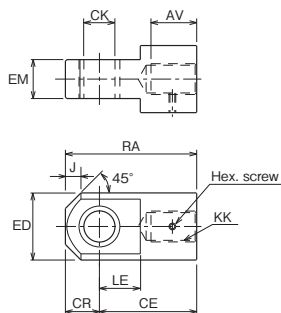

● If the rod A is used, change the rod end thread diameter to that of the rod B.

● Rod clevis (Y-end) with pin

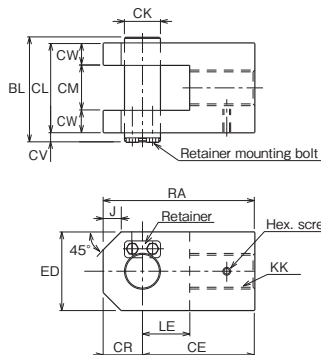

● If the rod A is used, change the rod end thread diameter to that of the rod B.

● Delivery of rod end attachment (T-end or Y-end)

① When the lock nut and rod end attachment are additionally ordered
The rod end attachment and lock nut are temporarily assembled to the piston rod for delivery. Since the lock nut is not tightened, tighten it after adjusting the position of the rod end attachment.
No hex. screw is supplied.

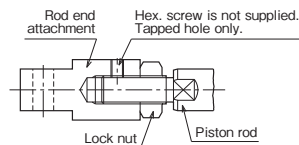

② When only the rod end attachment is additionally ordered (without lock nut)
The rod end attachment is tightened to the piston rod, a drill hole is made on the piston rod and it is secured with the hex. screw for delivery.

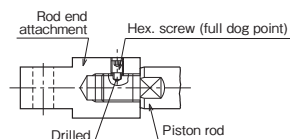

If the drilled hole is unnecessary, give us such instructions.

Dimensional Table: Rod eye (T-end)

Symbol	Rod B										
	Part number	AV	CE	CK	CR	ED	EM	J	KK	LE	RA
φ50	RTH-24-3-H	35	80	φ25H10	30	φ55	32 ^{-0.1} _{-0.4}	15	M24×1.5	34	110
φ63	RTH-30-2-H	40	95	φ32H10	35	φ70	40 ^{-0.1} _{-0.4}	16	M30×1.5	42	130
φ80	RTH-39-2-H	53	110	φ40H10	40	φ80	50 ^{-0.1} _{-0.4}	15	M39×1.5	52	150
φ100	RTH-48-2-H	62	135	φ50H10	50	φ98	63 ^{-0.1} _{-0.6}	20	M48×1.5	65	185
φ125	RTH-64-3-H	80	160	φ63H10	63	φ118	80 ^{-0.1} _{-0.6}	30	M64×2	75	223
φ140	RTH-72-3-H	87	180	φ70H10	70	φ138	90 ^{-0.1} _{-0.6}	35	M72×2	82	250
φ160	RTH-80-3-H	96	195	φ80H10	80	φ158	100 ^{-0.1} _{-0.6}	40	M80×2	94	275

Dimensional Table: Rod clevis (Y-end) with pin

Symbol	Rod B													
	Part number	BL	CE	CK	CL	CM	CR	CV	CW	ED	J	KK	LE	RA
φ50	RYH-24-3-H	77	80	φ25 ^{H10} ₁₈	64	32 ^{+0.4} _{+0.1}	30	8	16	60	15	M24×1.5	34	110
φ63	RYH-30-1-H	93	95	φ32 ^{H10} ₁₈	80	40 ^{+0.4} _{+0.1}	35	8	20	70	16	M30×1.5	42	130
φ80	RYH-39-2-H	117	110	φ40 ^{H10} ₁₈	100	50 ^{+0.4} _{+0.1}	40	12	25	80	15	M39×1.5	52	150
φ100	RYH-48-2-H	143	135	φ50 ^{H10} ₁₈	126	63 ^{+0.4} _{+0.1}	50	12	31.5	100	20	M48×1.5	65	185
φ125	RYH-64-3-H	183	160	φ63 ^{H10} ₁₈	160	80 ^{+0.6} _{+0.1}	63	18	40	120	30	M64×2	75	223
φ140	RYH-72-3-H	203	180	φ70 ^{H10} ₁₈	180	90 ^{+0.6} _{+0.1}	70	18	45	140	35	M72×2	82	250
φ160	RYH-80-3-H	223	195	φ80 ^{H10} ₁₈	200	100 ^{+0.6} _{+0.1}	80	18	50	160	40	M80×2	94	275

Note) ● The rod end attachments are dedicated to the rod B. To use them for the rod A, give instructions to change the rod A end thread diameter to that of the rod B.
When the rod end attachment and the lock nut are used for a cylinder with the rod A, give instructions to change the rod end thread diameter to the thread diameter of the rod B and change dimension A to that for the use of lock nut.

● Lock nut

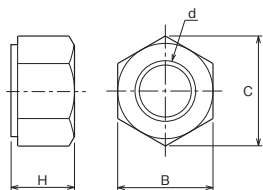

● Thread length of rod end with lock nut

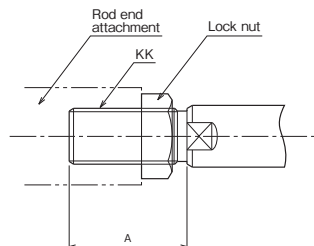

The standard fitting length of the rod end attachment and piston rod is about 80% of the thread diameter. Therefore, if you order a cylinder with a lock nut, dimension A is longer.

● Parallel pin

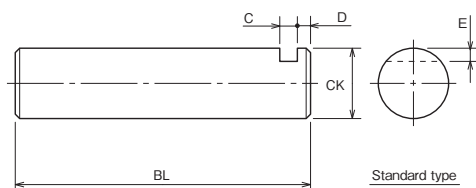

● Retainer

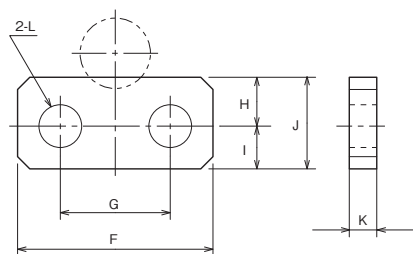

Dimensional Table: Dimension A when lock nut is used (long thread)

Symbol Bore	Rod B		Rod A	
	A	KK	A	KK
φ50	50	M24×1.5	60	M30×1.5
φ63	60	M30×1.5	80	M39×1.5
φ80	80	M39×1.5	95	M48×1.5
φ100	95	M48×1.5	125	M64×2
φ125	125	M64×2	155	M80×2
φ140	140	M72×2	185	M95×2
φ160	155	M80×2	190	M100×2

Dimensional Table: Lock nut

Symbol Bore	Part number	Rod B				Part number	Rod A			
		B	C	d	H		B	C	d	H
φ50	LNH-24F-1-H	36	41.6	M24×1.5	20	LNH-30F-1-H	46	53.1	M30×1.5	25
φ63	LNH-30F-1-H	46	53.1	M30×1.5	25	LNH-39F-1-H	60	69.3	M39×1.5	32
φ80	LNH-39F-1-H	60	69.3	M39×1.5	32	LNH-48F-1-H	75	86.6	M48×1.5	38
φ100	LNH-48F-1-H	75	86.6	M48×1.5	38	LNH-64F-1-H	95	109.7	M64×2	51
φ125	LNH-64F-1-H	95	109.7	M64×2	51	LNH-80F-1-H	115	132.8	M80×2	64
φ140	LNH-72F-1-H	105	121.2	M72×2	58	LNH-95F-1-H	135	155.9	M95×2	76
φ160	LNH-80F-1-H	115	132.8	M80×2	64	LNH-100F-1-H	145	167.4	M100×2	80

Dimensional Table: Parallel pin

Symbol Bore	BL	C	CK	D	E
φ50	77	5	φ25	3	3.5
φ63	93	5	φ32	3	4
φ80	117	7	φ40	5	5
φ100	143	7	φ50	5	5
φ125	183	10	φ63	8	8
φ140	203	10	φ70	8	8
φ160	223	10	φ80	8	8

● The tolerance of CK is f8.

Dimensional Table: Retainer

Symbol Bore	F	G	H	I	J	K	L	Retainer mounting bolt size
φ50	32	18	8	7	15	4.5	φ7	M6
φ63	32	18	8	7	15	4.5	φ7	M6
φ80	50	30	10	8	18	6	φ10	M8
φ100	65	40	12	10	22	6	φ12	M10
φ125	75	48	17	13	30	9	φ14	M12
φ140	75	48	17	13	30	9	φ14	M12
φ160	75	48	17	13	30	9	φ14	M12